

BONALDO

Pisa

Designer: Mauro Lipparini



I tavolini Pisa, disegnati da Mauro Lipparini, sono complementi dal forte carattere, grazie al design monolitico della base. Disponibili in versione monovolume con piano incassato oppure con piano a cappello, si caratterizzano per il taglio della base che, come la celeberrima torre omonima, si sviluppa diagonalmente. Fil rouge della collezione è il metallo, in cui viene realizzata la base: il tavolino acquisisce poi una sua identità personale a seconda del materiale del piano, disponibile in ceramica, cristallo, marmo oppure in metallo nella stessa finitura della base.



Scheda tecnica

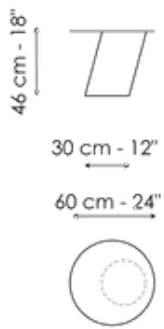

Pisa Ø60 - versione con piano

Larghezza: 60cm
Profondità: 60cm
Altezza: 46cm

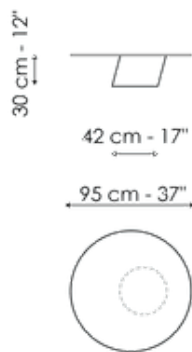

Pisa Ø95 - versione con piano

Larghezza: 95cm
Profondità: 95cm
Altezza: 30cm

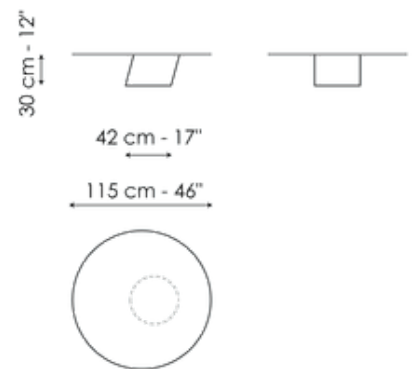

Pisa Ø115 - versione con piano

Larghezza: 115cm
Profondità: 115cm
Altezza: 30cm

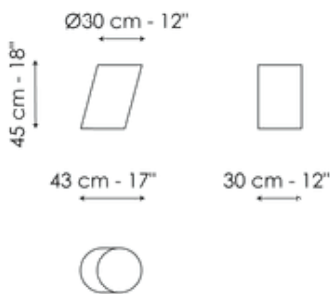

Pisa high- versione a monolite

Larghezza: 30cm
Profondità: 43cm
Altezza: 45cm

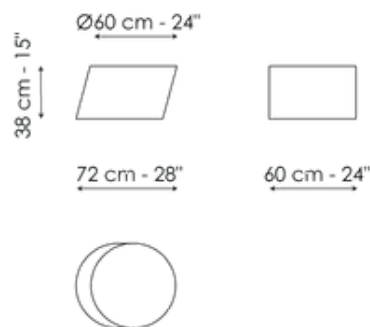

Pisa medium - versione a monolite

Larghezza: 60cm
Profondità: 72cm
Altezza: 38cm

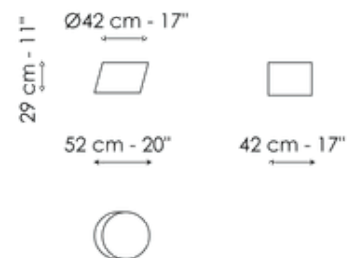

Pisa low - versione a monolite

Larghezza: 42cm
Profondità: 52cm
Altezza: 29cm

Finishes

Piano - versione con piano

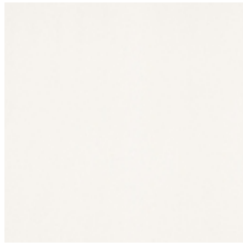

Ceramica opaca
Bianco iridium



Ceramica opaca
Grigio grafite

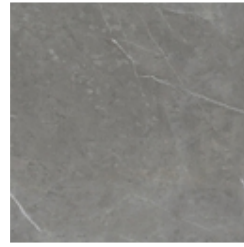

Ceramica opaca
Grigio Ardesia

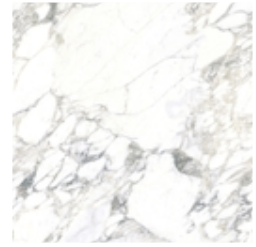

Ceramica lucida
Calacatta



Ceramica opaca
Laurent



Ceramica finitura seta
Calacatta macchia vecchia

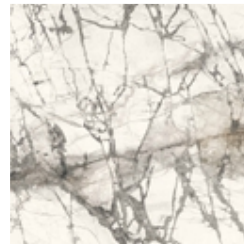

Ceramica lucida
Imperial grey

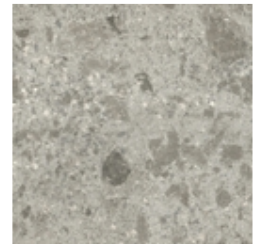

Ceramica opaca
Stone grey

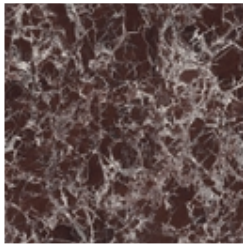

Ceramica lucida
Rosso imperiale

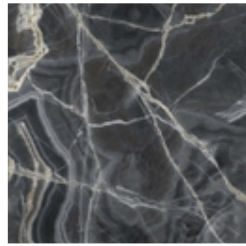

Ceramica lucida
Black Onyx

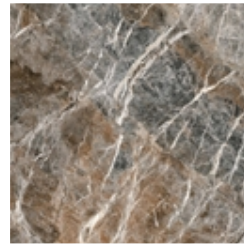

Ceramica lucida
Mountain peak

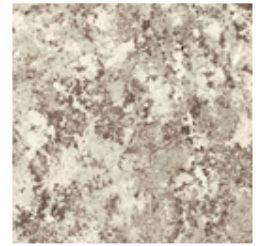

Ceramica opaca
Alaska White



Ceramica opaca
Augusta



Cristallo
Fumè



Cristallo
Bronzato

Piano - versione a monolite

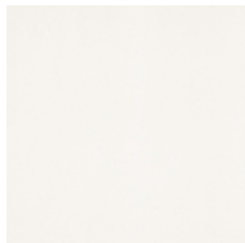

Ceramica opaca
Bianco iridium

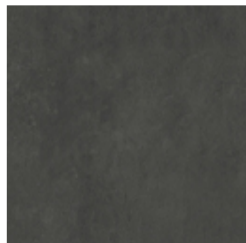

Ceramica opaca
Grigio grafite

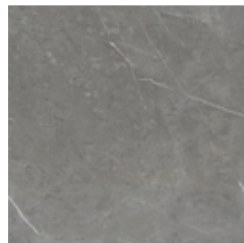

Ceramica opaca
Grigio Ardesia



Ceramica lucida
Calacatta

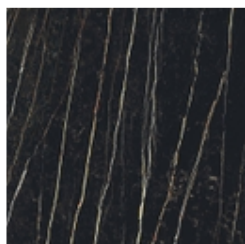

Ceramica opaca
Laurent

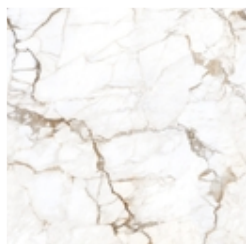

Ceramica finitura seta
Calacatta macchia vecchia

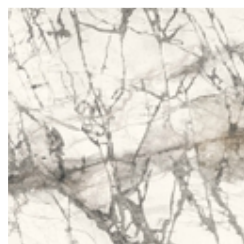

Ceramica lucida
Imperial grey

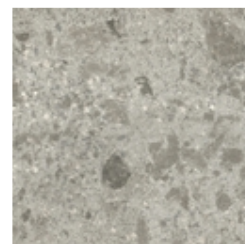

Ceramica opaca
Stone grey

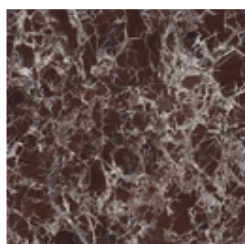

Ceramica lucida
Rosso imperiale

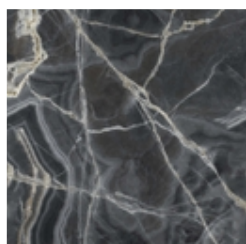

Ceramica lucida
Black Onyx

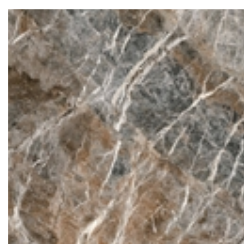

Ceramica lucida
Mountain peak

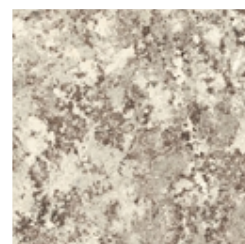

Ceramica opaca
Alaska White



Ceramica opaca
Augusta



Marmo
Travertino Romano

Base



Metallo verniciato
Supreme anthracite



Metallo verniciato
Nero opaco



Metallo verniciato
Rame opaco



Metallo verniciato
Ottone opaco

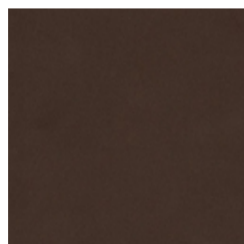

Metallo verniciato
Bronzo opaco

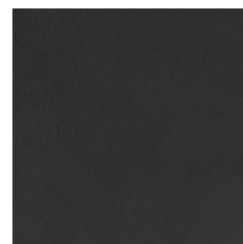

Metallo verniciato
Piombo opaco



Metallo verniciato
Oro perlato opaco

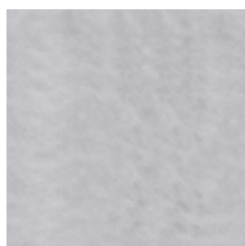

Metallo finitura
Clouded chrome



Metallo finitura
Brown nickel



Metallo finitura
Dark nickel

Materiali, tessuti, colori e finiture sono puramente indicativi e possono variare da quelli attualmente rappresentati. Potete trovare la collezione completa di tessuti e pelli nel sito dedicato <https://bonaldo.biz>