

BONALDO

Padiglioni



Il tavolo di design con base asimmetrica Padiglioni di Alain Gilles è ispirato all'iconico padiglione di Barcellona progettato da Mies van der Rohe. Il punto focale di questo tavolo è la base che si compone di tre elementi asimmetrici, ognuno con una forma peculiare e collocati in posizione apparentemente casuale per rendere la composizione visivamente dinamica. Proprio per questa asimmetria della base chi lo osserva da vicino noterà, spostandosi intorno al tavolo, che cambia aspetto in base al punto di osservazione. Una struttura importante, accentuata dal piano del tavolo la cui forma lineare con bordo inclinato contrasta con le gambe e ne completa l'immagine di insieme. Una storia di contrasti che dialogano tra loro e di equilibri sapientemente raggiunti, il tavolo Padiglioni è massima espressione dell'abilità creativa di Alain Gilles e della capacità produttiva di Bonaldo.



Scheda tecnica

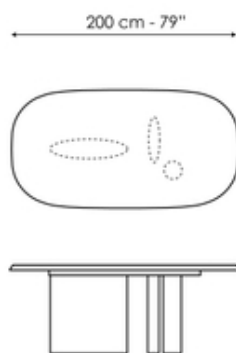

Larghezza: 200cm
Profondità: 104cm
Altezza: 76cm

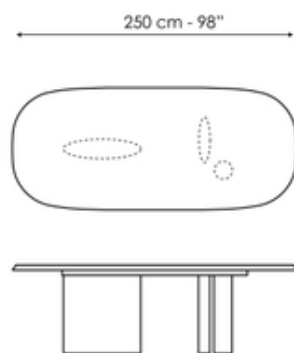

Larghezza: 250cm
Profondità: 108cm
Altezza: 76cm

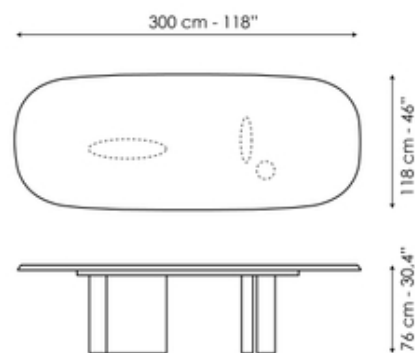

Larghezza: 300cm
Profondità: 118cm
Altezza: 76cm

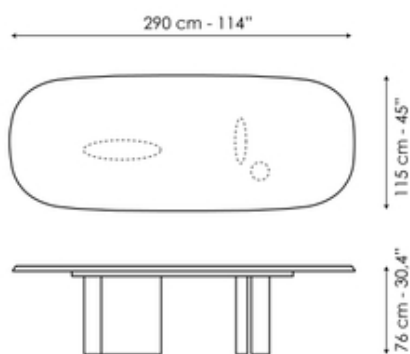

Larghezza: 290cm
Profondità: 115cm
Altezza: 76cm

Finishes

Mono Material

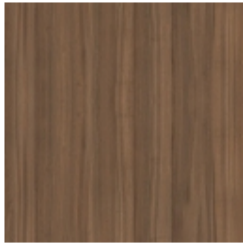

Legno impiallacciato
Noce Canaletto



Legno impiallacciato
Rovere spazzolato carbone



Legno impiallacciato
Rovere Grey spazzolato



Argilla spatolata a mano
Terracotta



Argilla spatolata a mano
Glacier

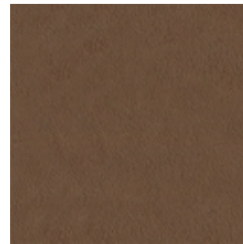

Argilla spatolata a mano
Terre



Argilla spatolata a mano
Neige

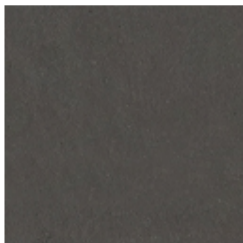

Argilla spatolata a mano
Graphite



Argilla spatolata a mano
Perle

Double Material Wood

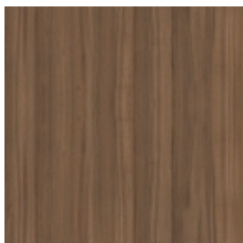

Legno impiallacciato
Noce Canaletto



Legno impiallacciato
Rovere spazzolato carbone



Legno impiallacciato
Rovere Grey spazzolato

Double Material Wood

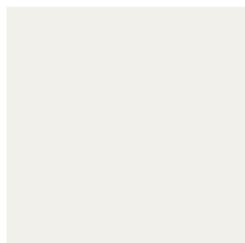

Metallo verniciato
Bianco opaco

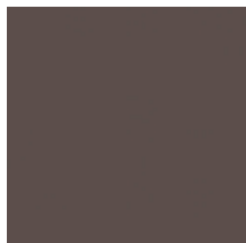

Metallo verniciato
Marrone opaco



Metallo verniciato
Supreme anthracite



Metallo verniciato
Nero opaco



Metallo verniciato
Tortora opaco



Metallo verniciato
Rame opaco



Metallo verniciato
Ottone opaco

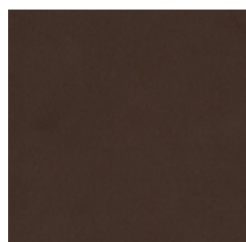

Metallo verniciato
Bronzo opaco

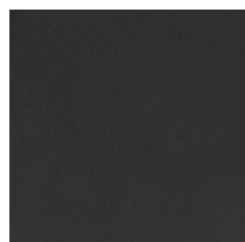

Metallo verniciato
Piombo opaco



Metallo verniciato
Oro perlato opaco

Double Material Ceramic - Marble

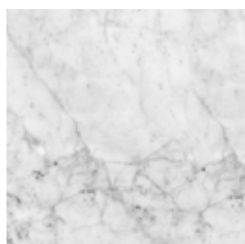

Marmo
Carrara

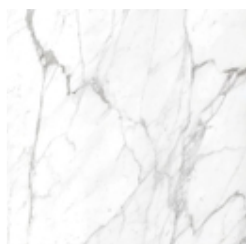

Marmo
Calacatta

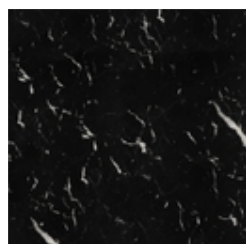

Marmo
Marquinia

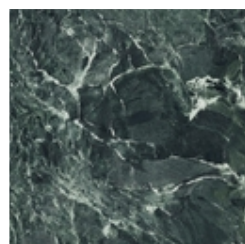

Marmo
Saint Denis



Marmo
Rosso Carpazi

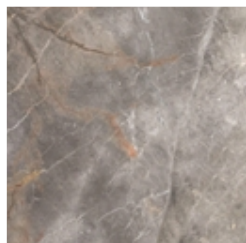

Marmo
Fior di bosco



Marmo
Travertino Romano

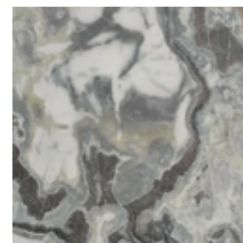

Marmo
Dover White



Ceramica finitura seta
Calacatta macchia vecchia

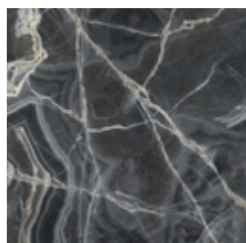

Ceramica lucida
Black Onyx



Ceramica opaca
Augusta

Double Material Ceramic - Marble

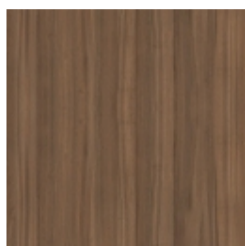

Legno impiallacciato
Noce Canaletto



Legno impiallacciato
Rovere spazzolato carbone



Legno impiallacciato
Rovere Grey spazzolato

Materiali, tessuti, colori e finiture sono puramente indicativi e possono variare da quelli attualmente rappresentati. Potete trovare la collezione completa di tessuti e pelli nel sito dedicato <https://bonaldo.biz>