

BUSTER + PUNCH
LONDON



[range. **CUSTOM ELECTRICITY.**]

BUSTER+PUNCH

LONDON

[product.

EUROPEAN CUSTOM ELECTRICITY.]

Buster + Punch's Electricity collection is a one-stop solution that effortlessly ties together entire spaces, homes and contract interiors. The units feature a flat plate and are crowned with our trademark coin screws and diamond-cut knurled knobs and toggles – for unrivalled tactility.

Select from complete solid metal fixtures in white, steel, brass, smoked bronze and black with additional detail kits for customisation. The range is optimised, fully engineered and code approved for European residential and contract applications.

[how. **CREATE YOUR OWN CUSTOM SWITCH, DIMMER OR MODULE DESIGNS.**]



CONTENTS

TOGGLE SWITCHES	3
DIMMERS	7
SOCKETS / SCHUKO TYPE F	10
EU PLATES / HORIZONTAL	14
WALL PLATES / VERTICAL	19
WALL PLATES / NO INFILL	23
SOCKET MODULES	29
MODULES	30
SWITCH MODULES	32
DIMMER MODULES	33
BACKBOXES	34

EXAMPLE 2



MODULE
[module. DOUBLE TOGGLE.]
[module. DIMMER.]
[module. DIMMER.]
PLATE
[plate. 3G BLACK.]
DETAIL KIT
[module. TOGGLE / BRASS.]
[module. DIMMER / BRASS.]
[module. OUTLET / BRASS.]

BUSTER+PUNCH

LONDON

[product.

TOGGLE SWITCHES

[knurl. **CROSS.**]

[range. **ELECTRICITY.**]

[born. **LONDON.**]

A solid metal toggle switch with diamond-cut knurling. The switch is finished with a solid metal flat plate and our signature coin screws. Available in five different finishes, they can be used in combination with our matching dimmers, sockets and USB outlets

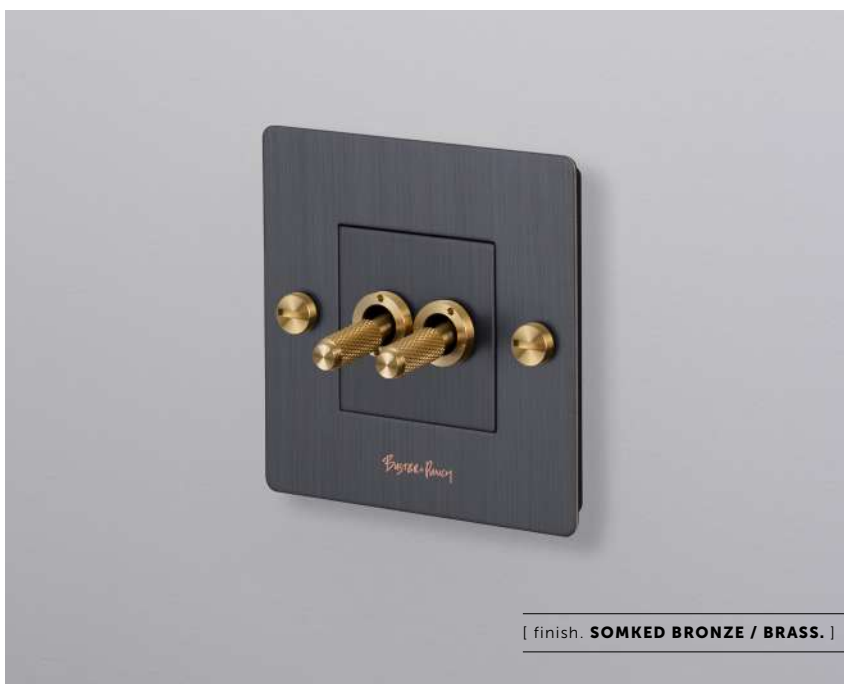
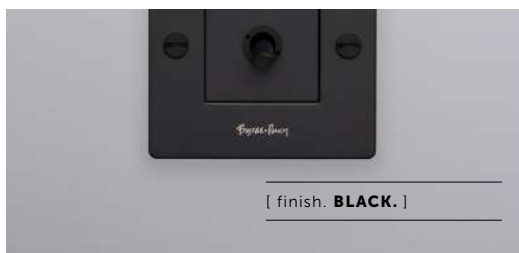

[type. **1G TOGGLE SWITCH.**]

[info. **MEASUREMENTS.**]

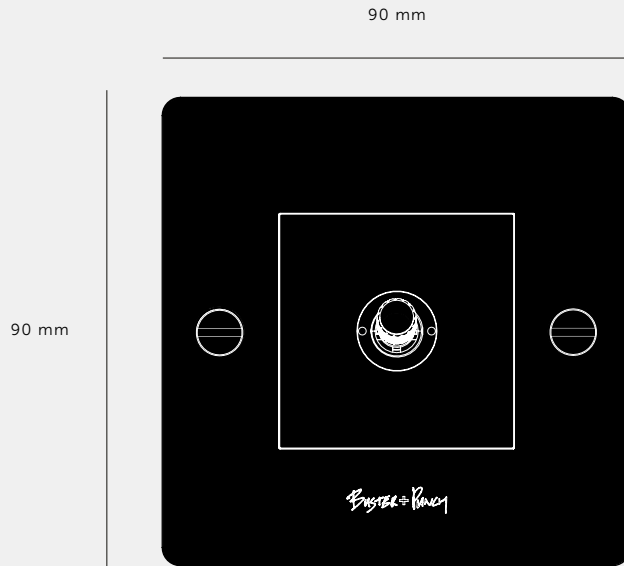

[info. **SPECIFICATIONS.**]

A 1G toggle switch. The toggle arm is made from solid metal and features our signature, diamond-cut, cross knurl pattern. This switch is 2 way.

[info. **SPECIFICATIONS.**]

Module Code: CTM-142035 (1 per unit)

Style: On / Off Toggle Switch

10AX 250VAC ONLY

2 way switching (can be controlled from 2 locations)

*Certified for use in UK, Europe and Russia :

UKCA / CE / EAC

[info. **CARE INSTRUCTIONS.**]

Wipe with damp cloth with no loose hairs, avoid using any chemicals. Please note that finishes may age naturally with time and regular use.

[info. **FINISH & SKU NUMBERS.**]

[finish.]	[sku.]
White	CTG-141964
Steel	CTG-071967
Brass	CTG-051966
Smoked Bronze	CTG-091968
Black	CTG-021965

[please. **NOTE.**]

DISCLAIMER: Always consult a trade professional when installing this toggle switch. Buster + Punch is not responsible for the usage or feasibility of installation requirements. This product is not suitable for damp or wet environments.

[type. **2G TOGGLE SWITCH.**]

[info. **MEASUREMENTS.**]

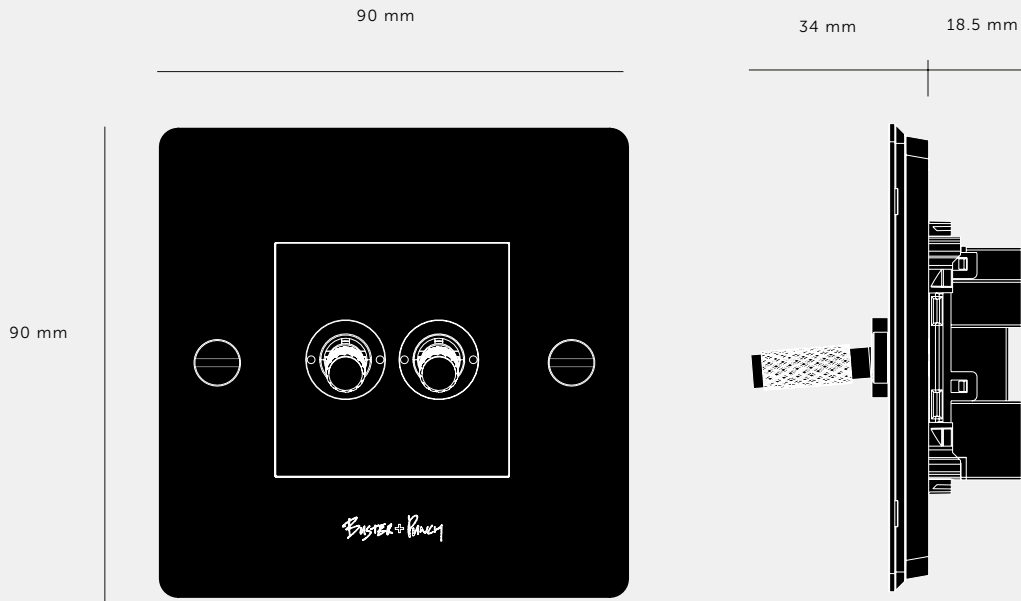

[info. **SPECIFICATIONS.**]

A 1G double toggle switch. The toggle arm is made from solid metal and features our signature, diamond-cut, cross knurl pattern. This switch is 2 way.

[info. **SPECIFICATIONS.**]

Module Code: CTM-142035 (2 per unit)

Style: On / Off Toggle Switch

10AX 250VAC ONLY

2 way switching (can be controlled from 2 locations)

*Compatible with 2-3 Way switching

*Certified for use in UK, Europe and Russia: CE / EAC

[info. **FINISH & SKU NUMBERS.**]

[finish.]

[sku.]

White	CTG-141969
Steel	CTG-071972
Brass	CTG-051971
Smoked Bronze	CTG-091973
Black	CTG-021970

[info. **CARE INSTRUCTIONS.**]

Wipe with damp cloth with no loose hairs, avoid using any chemicals. Please note that finishes may age naturally with time and regular use.

[please. **NOTE.**]

DISCLAIMER: Always consult a trade professional when installing this toggle switch. Buster + Punch is not responsible for the usage or feasibility of installation requirements. This product is not suitable for damp or wet environments.

CATEGORY	QUESTION	ANSWER
TOGGLE	Do you stock an intermediate (3 way switch)?	Yes, you can select the intermediate switch module in the 'custom plates and modules' option. Intermediate 3 way Toggle Switch (CTM-142037)
TOGGLE	Are your switches suitable for smart homes?	We produce a Single Throw 2-way retractive switch (CTM-142036); it is sprung and sends a momentary signal returning to its original state after being pressed. It's useful in smart home applications because that signal can be programmed to trigger a wide variety of functions.
CUSTOMISE	Can I customise the appearance of my toggle switch?	Our toggle modules are customisable with interchangeable 'detail kits' in five finishes. Refer to our website for options, or contact one of our sales representatives for more information.
CUSTOMISE	I need more than 2 switches in the same location. Do I need to have separate plates?	Aside from our single and double toggle complete products, we supply plates up to 4G with interchangeable modules and detail kits for ultra-flexibility. Please refer to our website for purchasing options, or contact one of our sales representatives for more information.
CUSTOMISE	Can I combine different modules on the same plate?	Our plates are designed to fit a combination of sockets, dimmers and toggles. Please refer to our website for options, or contact one of our sales representatives for more information.
INSTALL	Can I install my toggle myself?	We strongly recommend that our products are always installed by a qualified electrician. Always refer to the safety notices within the instruction manual before attempting any electrical installation.

BUSTER+PUNCH

LONDON

[product.

DIMMERS

[knurl. **CROSS.**]

[range. **ELECTRICITY.**]

[born. **LONDON.**]

A solid metal dimmer switch with diamond-cut knurling. The switch is finished with a solid metal flat plate and our signature coin screws. Available in five different finishes, they can be used in combination with our matching toggle switches, sockets and USB outlets.

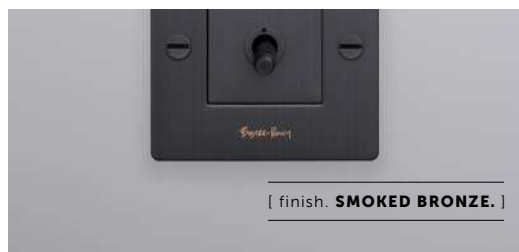

[type. **DIMMER MODULE/ 250W LED/ RETRACTIVE MULTI-LOCATION.**]

[info. **MEASUREMENTS.**]

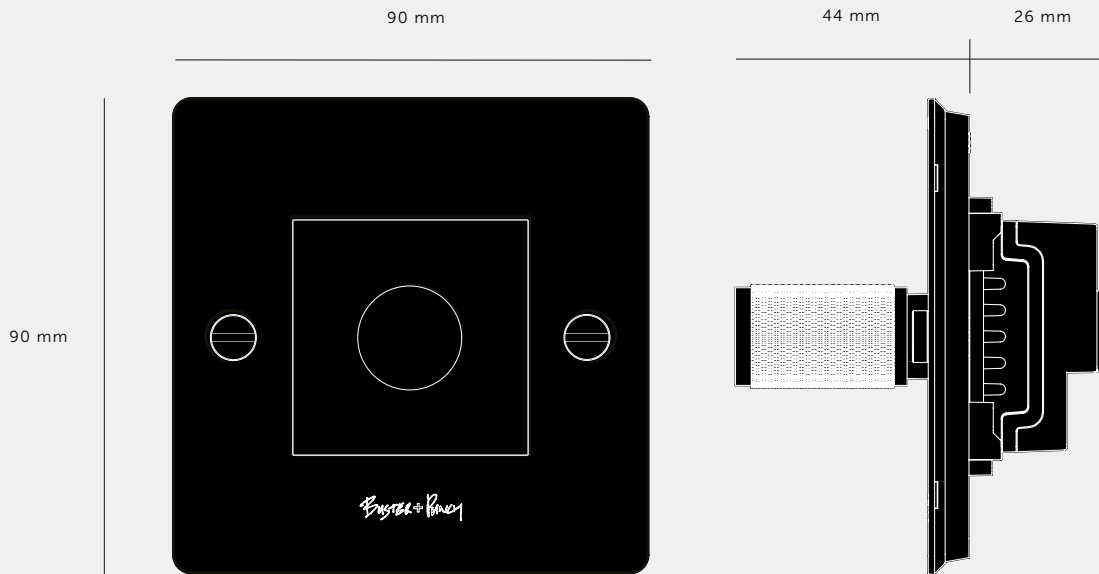

[info. **SPECIFICATIONS.**]

A 1G dimmer switch. Includes matching solid metal dimmer knob with our signature cross-knurl and coin screws.

Retractive switch compatible only, 250W LED (max).

[info. **SPECIFICATIONS.**]

Module Code: CDM-142038 (1 per unit)

Style: Push ON/OFF rotary dimmer with multi location dimming via retractive switches.

Input: 240VAC ~ 50Hz

Dimming Type:

Auto Detect Trailing / Leading edge dimming

10-350W: When used with incandescent lamps

3-250W: When used with dimmable LED lamps.

Operating Temperature: 0-55 C Humidity: 10-90% R.H .

Certified for use in UK, Europe and Russia: UKCA / CE / EAC

*Not compatible with regular retractive switching

[info. **CARE INSTRUCTIONS.**]

Wipe with damp cloth with no loose hairs, avoid using any chemicals. Please note that finishes may age naturally with time and regular use.

[info. **FINISH & SKU NUMBERS.**]

[finish.]	[sku.]
White	CDR-141974
Steel	CDR-071977
Brass	CDR-051976
Smoked Bronze	CDR-091978
Black	CDR-021975

[please. **NOTE.**]

DISCLAIMER: Always consult a trade professional when installing this toggle switch. Buster + Punch is not responsible for the usage or feasibility of installation requirements. This product is not suitable for damp or wet environments.

[type. **DIMMER MODULE / 100W LED / 2 WAY**]

[info. **MEASUREMENTS.**]

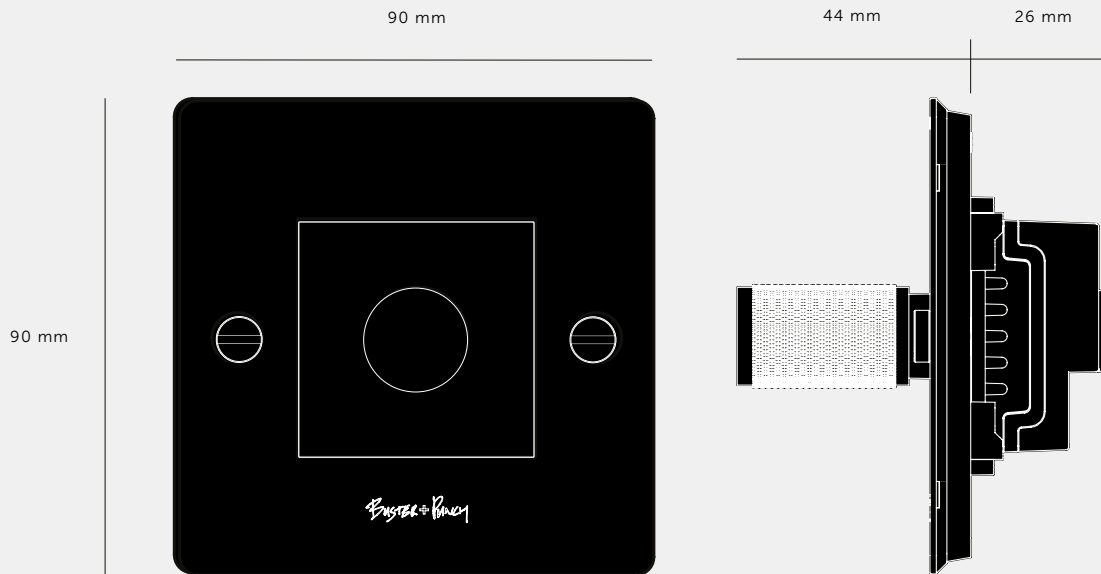

[info. **SPECIFICATIONS.**]

A 1G dimmer switch. Includes matching solid metal dimmer knob with our signature cross-knurl and coin screws.

2-3 way switch compatible only, 100w LED (max).

[info. **SPECIFICATIONS.**]

Module Code: CDM-012405 (1 per unit)

Style: Push ON/OFF rotary dimmer with 2 way switching

Compatible with regular 2-3 Way switching

Input: 250VAC 50Hz

Dimming Type: Trailing edge dimming

10-250W: When used with incandescent lamps

2-100W: When used with dimmable LED lamps.

Operating Temperature: 0 - 55 C Humidity: 10 - 90% R.H.

Certified for use in UK, Europe and Russia: UKCA / CE / EAC

*Not compatible with retractive switching.

[info. **CARE INSTRUCTIONS.**]

Wipe clean with a dry, non-abrasive microfiber cloth. Avoid use of chemical cleaners. Please note that finishes may age naturally with time and regular use.

[info. **FINISH & SKU NUMBERS.**]

[finish.]

[sku.]

White

CDR-142385

Steel

CDR-072388

Brass

CDR-052387

Smoked Bronze

CDR-092389

Black

CDR-022386

[please. **NOTE.**]

DISCLAIMER: Always consult a trade professional when installing this dimmer switch. Buster + Punch is not responsible for the usage or feasibility of installation requirements. This product is not suitable for damp or wet environments.

BUSTER+PUNCH

LONDON

[product.

SOCKETS / SCHUKO TYPE F

[knurl. **CROSS.**]

[range. **ELECTRICITY.**]

[born. **LONDON.**]

A power outlet finished with a solid metal flat plate and our signature coin screws. Available in five different finishes, they can be used in combination with our matching dimmers and toggle switches.

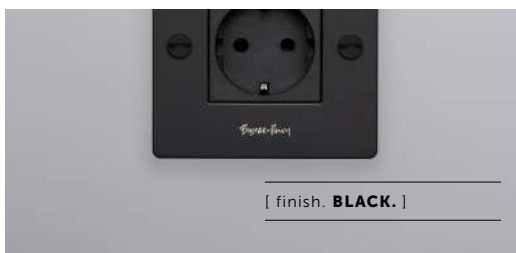
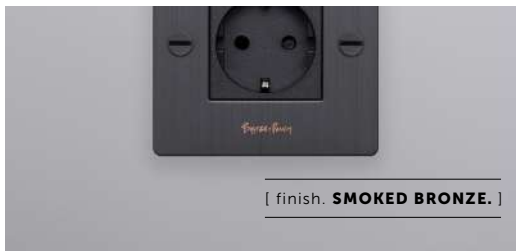

[type. **1G SCHUKO TYPE F SOCKET .**]

[info. **MEASUREMENTS.**]

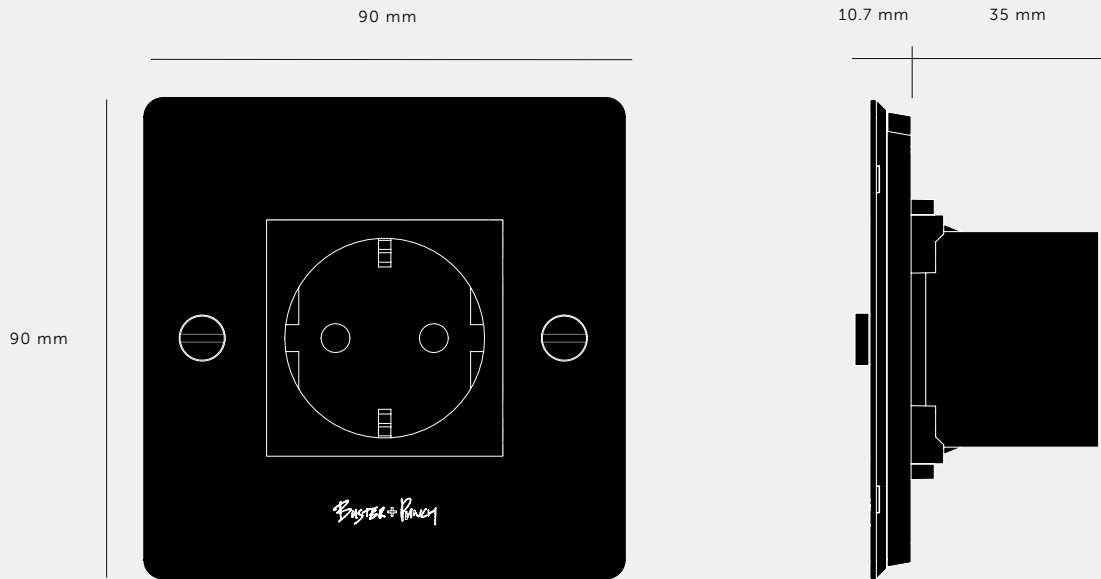

[info. **SPECIFICATIONS.**]

*For white products, module is finished in white.
For all other finishes (steel, brass, smoked bronze, black),
module is finished in black.

[info. **SPECIFICATIONS.**]





Module Code: CSM-021896/ CSM-141904 (1 per unit)

Style: Schuko Socket Type F

Outlet: 250 V ~ / 50-60 Hz / 16A

*Certified for use in UK, Europe and Russia: UKCA / CE / EAC

[info. **FINISH & SKU NUMBERS.**]

[finish.]	[sku.]
 White	CSC-141979
 Steel	CSC-071982
 Brass	CSC-051981
 Smoked Bronze	CSC-091983
 Black	CSC-021980

[info. **CARE INSTRUCTIONS.**]

Wipe with damp cloth with no loose hairs, avoid using any
chemicals. Please note that finishes may age naturally with
time and regular use.

[please. **NOTE.**]

DISCLAIMER: Always consult a trade professional when installing
this socket. Buster + Punch is not responsible for the usage
or feasibility of installation requirements. This product is not
suitable for damp or wet environments.

[type. **2G SCHUKO TYPE F SOCKET.**]

[info. **MEASUREMENTS.**]

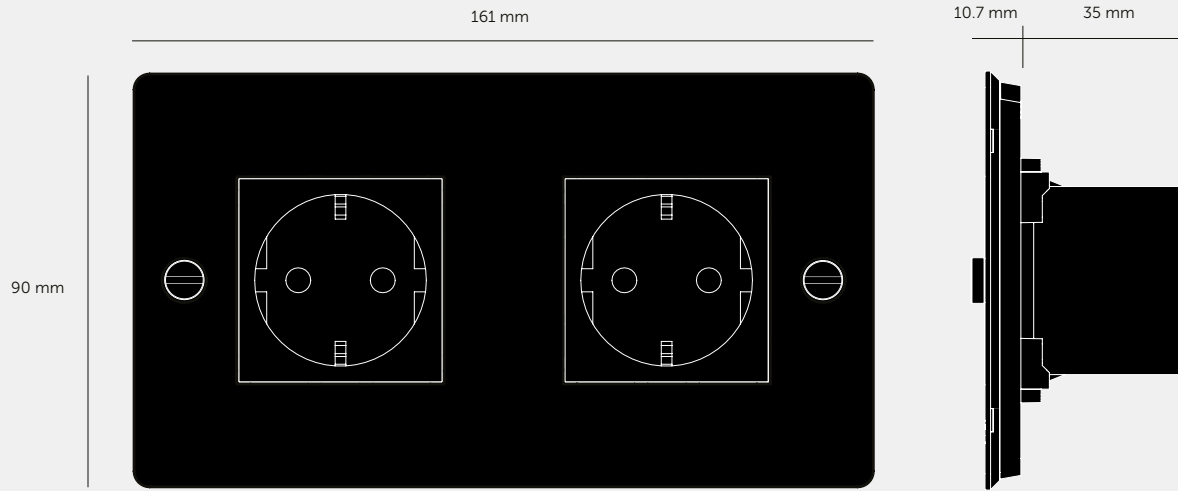

[info. **SPECIFICATIONS.**]

*For white products, module is finished in white.
For all other finishes (steel, brass, smoked bronze, black),
module is finished in black.

[info. **SPECIFICATIONS.**]

Module Code: CSM-021896 / CSM-141904 (2 per unit)

Style: Schuko Socket Type F

Outlet: 250 V ~ / 50-60 Hz / 16A

*Certified for use in UK, Europe and Russia: UKCA / CE / EAC

[info. **FINISH & SKU NUMBERS.**]

[finish.]	[sku.]
White	CSC-141984
Steel	CSC-071987
Brass	CSC-051986
Smoked Bronze	CSC-091988
Black	CSC-021985

[info. **CARE INSTRUCTIONS.**]

Wipe with damp cloth with no loose hairs, avoid using any
chemicals. Please note that finishes may age naturally with
time and regular use.

[please. **NOTE.**]

DISCLAIMER: Always consult a trade professional when installing
this toggle switch. Buster + Punch is not responsible for the
usage or feasibility of installation requirements. This product is
not suitable for damp or wet environments.

[type. **SOCKET.**]

[info. **FAQ SHEET.**]

CATEGORY	QUESTION	ANSWER
CUSTOMISE	Can I customise the appearance of my sockets?	Our plates are customisable with interchangeable 'detail kits' in five finishes. Please refer to our website for colour options.
CUSTOMISE	Can I combine different modules on the same plate?	Our plates are designed to accommodate a combination of modules, from 1G - 4G. Please refer to our website for purchasing options or contact one of our sales representatives for more information.
INSTALL	Can I install my socket myself?	We strongly recommend that our products are always installed by a qualified electrician. Always refer to the safety notices within the instruction manual before attempting any electrical installation.
INSTALL	Will this socket work with my existing wall box?	Please reference the key dimensions of the module and mounting holes when checking compatibility.

BUSTER+PUNCH

LONDON

[product.]

EU PLATES / HORIZONTAL

[with. **INFILLS.**]

[range. **ELECTRICITY.**]

[detail. **COIN SCREW.**]

EU Plates are made in a variety of finishes with our signature solid metal coin screws. EU plates can be combined with module inserts to suit all your electrical, data, sound & AV needs. Module inserts can be purchased seperately.

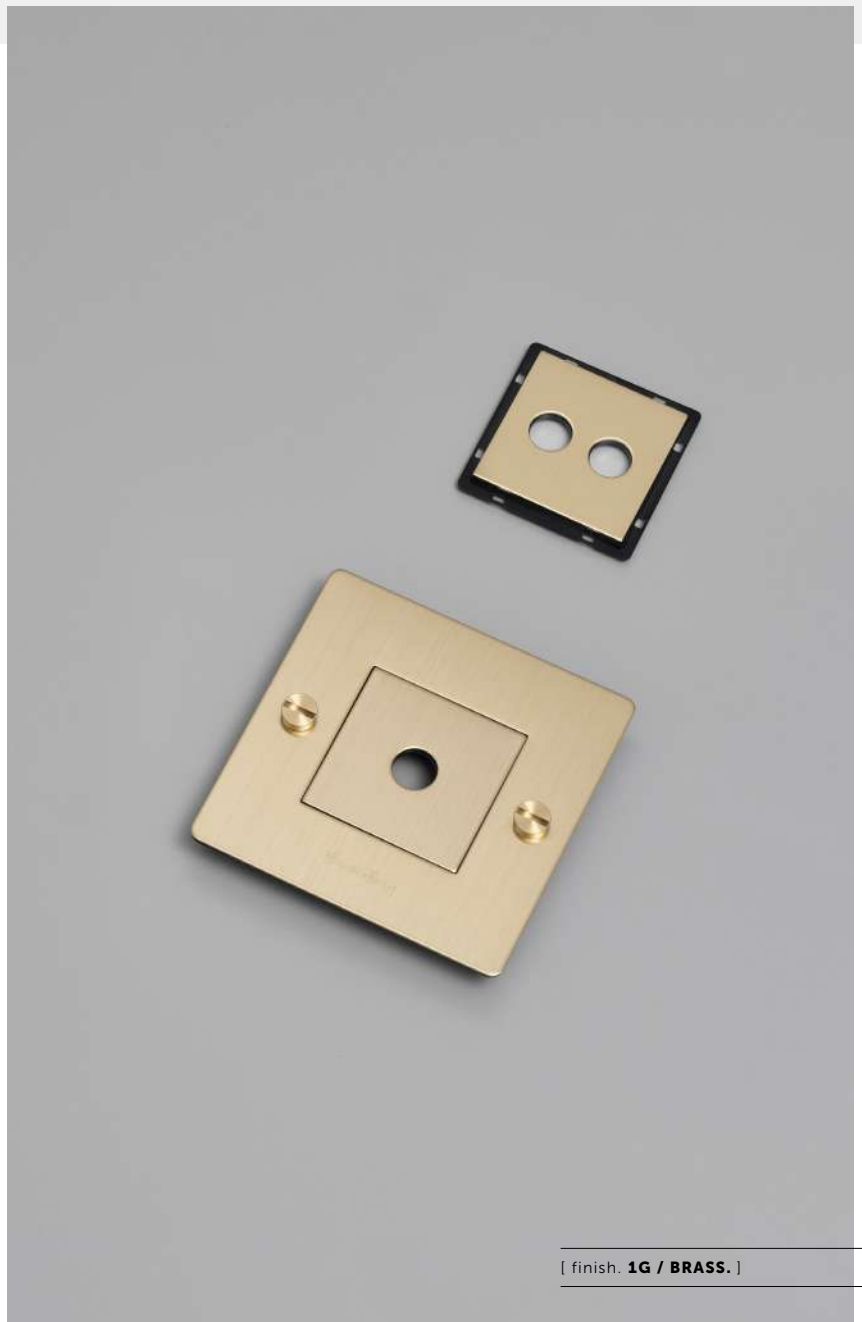

[type. **1G WALL PLATE.**]

[info. **MEASUREMENTS.**]

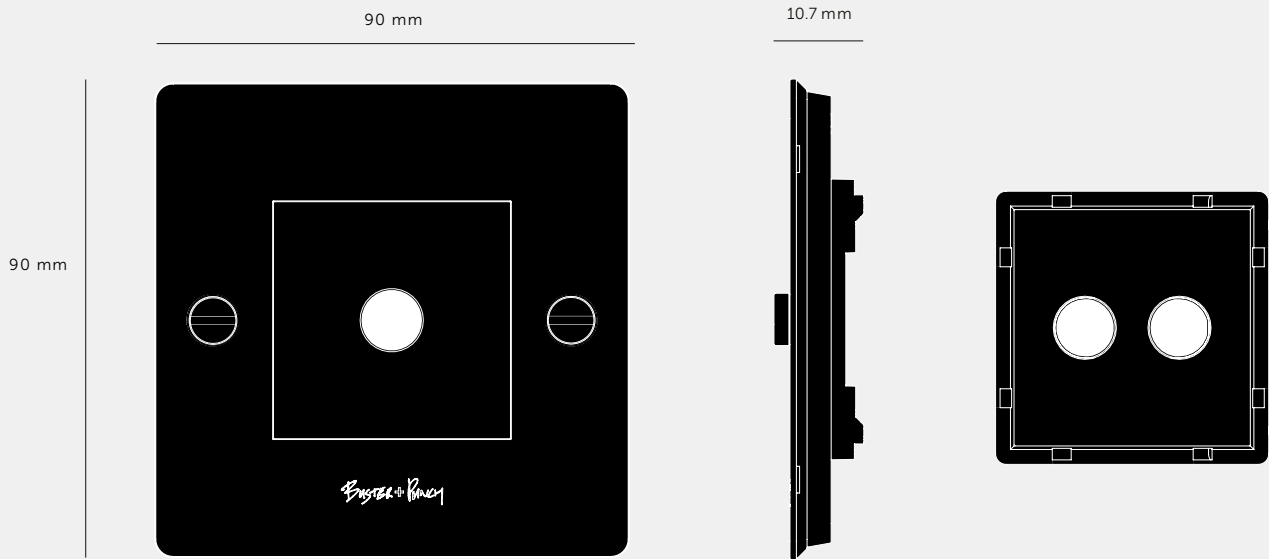

*For white products, module is finished in white.
For all other finishes (steel, brass, smoked bronze, black),
module is finished in black.

[info. **SPECIFICATIONS.**]





Each plate fits: up to 2 switches / 1 dimmer.

[info. **RECOMMENDED.**]

Each plate fits: up to 2 switches / 1 dimmer.

1G back box - depth depending on module insert.

[info. **FINISH & SKU NUMBERS.**]

[finish.]	[sku.]
 White	CPL-141989
 Steel	CPL-071992
 Brass	CPL-051991
 Smoked Bronze	CPL-091993
 Black	CPL-021990

[info. **CARE INSTRUCTIONS.**]

Wipe with damp cloth with no loose hairs, avoid using any
chemicals. Please note that finishes may age naturally with
time and regular use.

[please. **NOTE.**]

DISCLAIMER: Always consult a trade professional when installing
this wall plate. Buster + Punch is not responsible for the usage
or feasibility of installation requirements. This product is not
suitable for damp or wet environments.

[type. **2G WALL PLATE.**]

[info. **MEASUREMENTS.**]

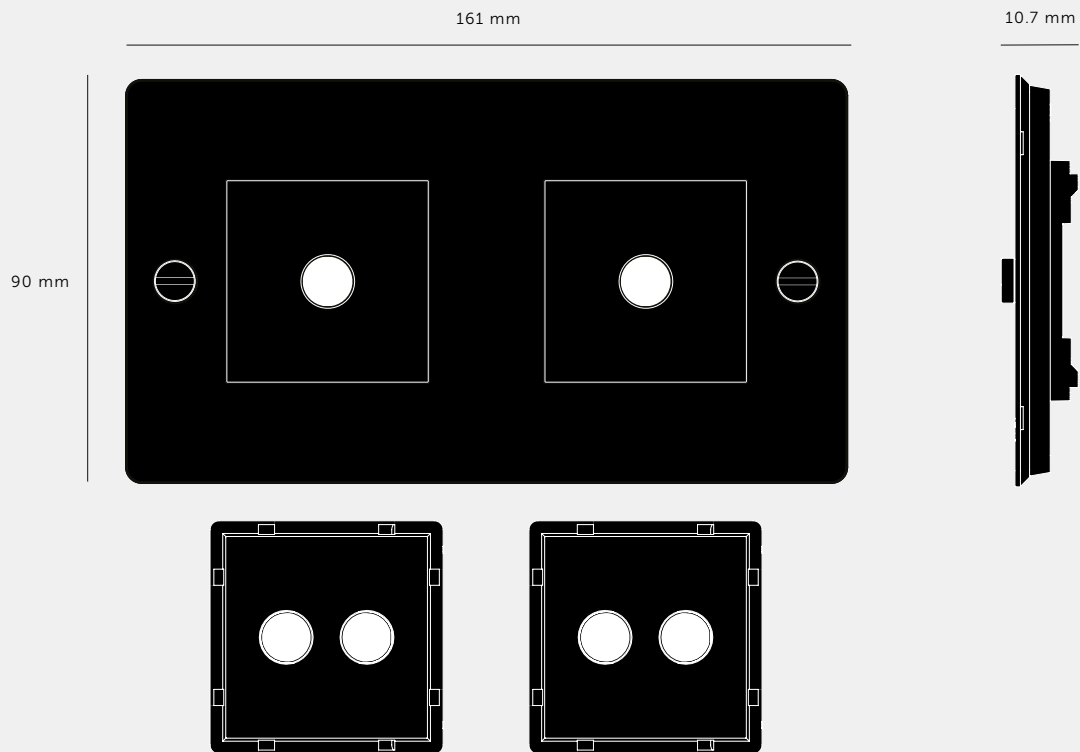

*For white products, module is finished in white.
For all other finishes (steel, brass, smoked bronze, black),
module is finished in black.

[info. **SPECIFICATIONS.**]

Each plate opening fits up to:

2 switches / 1 dimmer / 1 power / 1 module insert.

[info. **RECOMMENDED.**]

2G back box - depth depending on module insert.

[info. **FINISH & SKU NUMBERS.**]

[finish.]	[sku.]
● White	CPL-141994
● Steel	CPL-071997
● Brass	CPL-051996
● Smoked Bronze	CPL-091998
● Black	CPL-021995

[info. **CARE INSTRUCTIONS.**]

Wipe with damp cloth with no loose hairs, avoid using any
chemicals. Please note that finishes may age naturally with
time and regular use.

[please. **NOTE.**]

DISCLAIMER: Always consult a trade professional when installing
this wall plate. Buster + Punch is not responsible for the usage
or feasibility of installation requirements. This product is not
suitable for damp or wet environments.

[type. **3G WALL PLATE.**]

[info. **MEASUREMENTS.**]

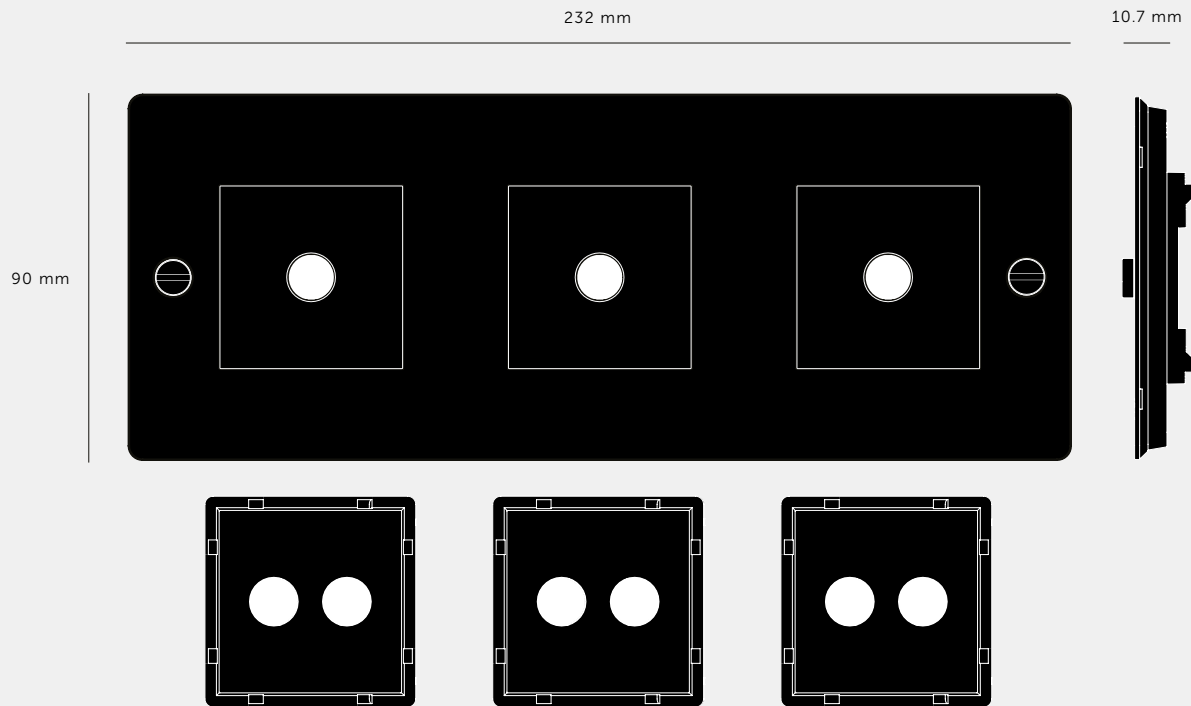

[info. **SPECIFICATIONS.**]





Each plate opening fits up to 2 switches / 1 dimmer / 1 power / 1 module insert.

*For white products, Socket & data inserts are finished in white. For all other finishes (steel, brass, smoked bronze, black), inserts are finished in black except for Swiss, Danish and Italian sockets, which are graphite.

[info. **RECOMMENDED.**]

3G back box - depth depending on module insert.

[info. **FINISH & SKU NUMBERS.**]

[finish.]	[sku.]
 White	CPL-141999
 Steel	CPL-072002
 Brass	CPL-052001
 Smoked Bronze	CPL-092003
 Black	CPL-022000

[info. **CARE INSTRUCTIONS.**]

Wipe with damp cloth with no loose hairs, avoid using any chemicals. Please note that finishes may age naturally with time and regular use.

[please. **NOTE.**]

DISCLAIMER: Always consult a trade professional when installing this wall plate. Buster + Punch is not responsible for the usage or feasibility of installation requirements. This product is not suitable for damp or wet environments.

[type. **4G WALL PLATE.**]

[info. **MEASUREMENTS.**]

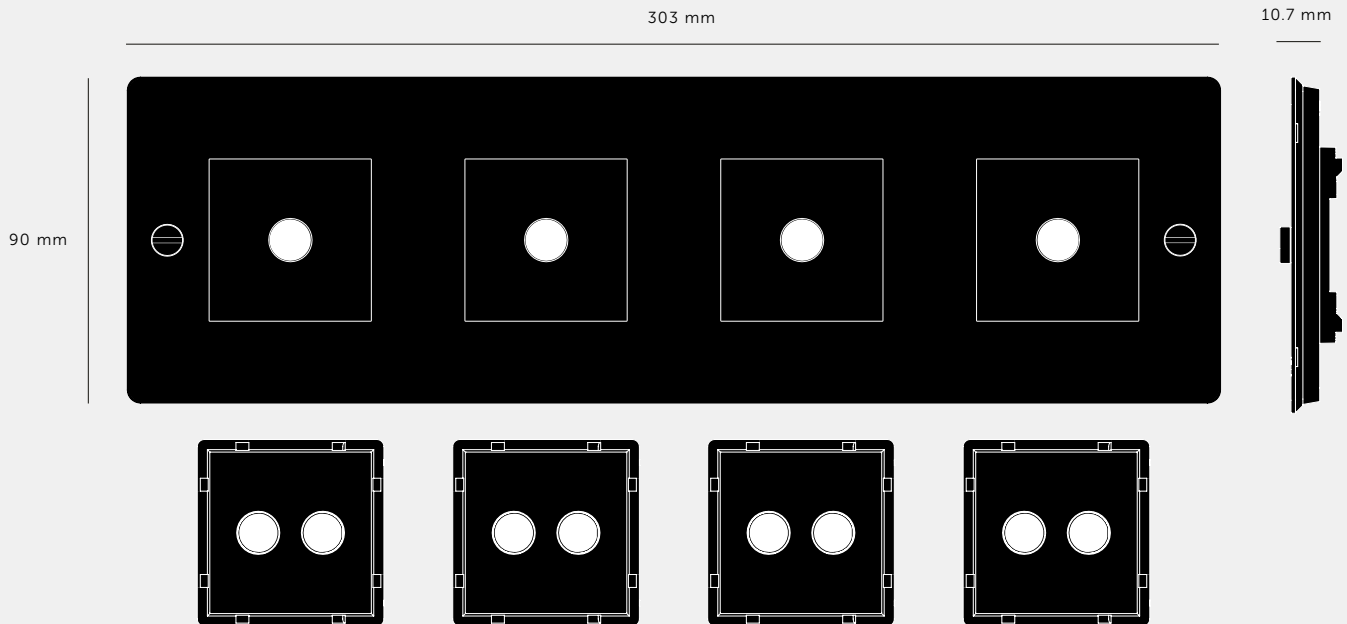

[info. **SPECIFICATIONS.**]

Each plate opening fits up to 2 switches / 1 dimmer / 1 power / 1 module insert.

*For white products, Socket & module inserts are finished in white. For all other finishes (steel, brass, smoked bronze, black), inserts are finished in black except for Swiss, Danish and Italian sockets, which are graphite.

[info. **RECOMMENDED.**]

4G back box - depth depending on module insert.

[info. **FINISH & SKU NUMBERS.**]

[finish.]	[sku.]
● White	CPL-142004
● Steel	CPL-072007
● Brass	CPL-052006
● Smoked Bronze	CPL-092008
● Black	CPL-022005

[info. **CARE INSTRUCTIONS.**]

Wipe with damp cloth with no loose hairs, avoid using any chemicals. Please note that finishes may age naturally with time and regular use.

[please. **NOTE.**]

DISCLAIMER: Always consult a trade professional when installing this wall plate. Buster + Punch is not responsible for the usage or feasibility of installation requirements. This product is not suitable for damp or wet environments.

BUSTER+PUNCH

LONDON

[product.

WALL PLATES / VERTICAL

[knurl. **CROSS.**]

[range. **ELECTRICITY.**]

[born. **LONDON.**]

EU Plates are made in a variety of finishes with our signature solid metal coin screws. EU plates can be combined with module inserts to suit all your electrical, data, sound & AV needs. Module inserts can be purchased separately.



[type. **2G WALL PLATE.**]

[info. **MEASUREMENTS.**]

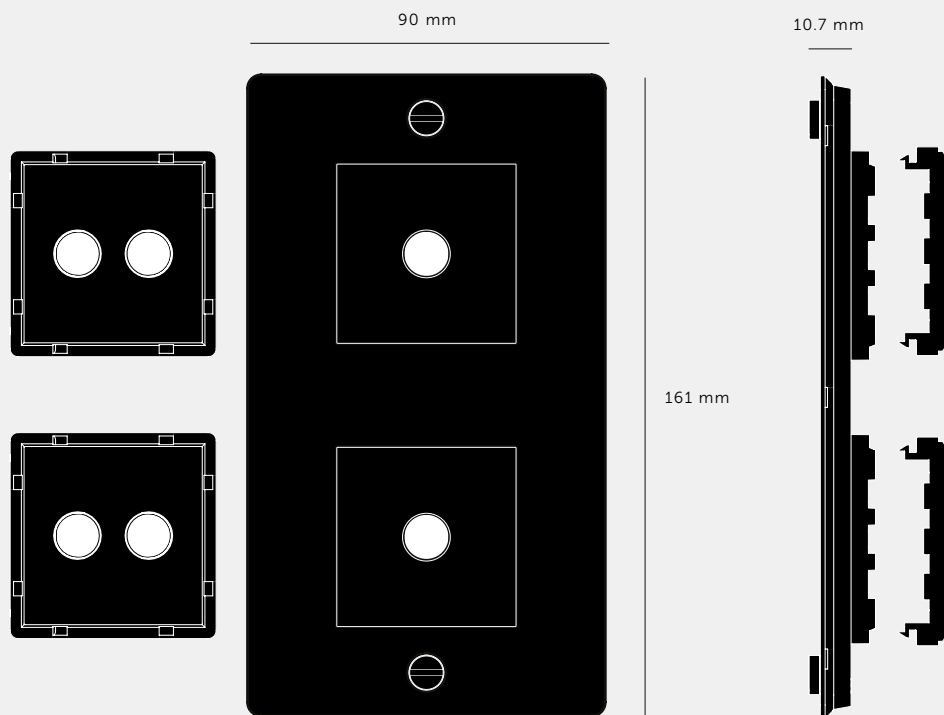

[info. **SPECIFICATIONS.**]

Each plate opening fits up to 2 switches / 1 dimmer / 1 power / 1 module insert.

*For white products, Socket & module inserts are finished in white. For all other finishes (steel, brass, smoked bronze, black), inserts are finished in black except for Swiss, Danish and Italian sockets, which are graphite.

[info. **RECOMMENDED.**]

2G back box - depth depending on module insert.

[info. **FINISH & SKU NUMBERS.**]

[finish.]	[sku.]
● White	CPL-142390
● Steel	CPL-072393
● Brass	CPL-052392
● Smoked Bronze	CPL-092394
● Black	CPL-022391

[info. **CARE INSTRUCTIONS.**]

Wipe with damp cloth with no loose hairs, avoid using any chemicals. Please note that finishes may age naturally with time and regular use.

[please. **NOTE.**]

DISCLAIMER: Always consult a trade professional when installing this wall plate. Buster + Punch is not responsible for the usage or feasibility of installation requirements. This product is not suitable for damp or wet environments.

[type. **3G WALL PLATE.**]

[info. **MEASUREMENTS.**]

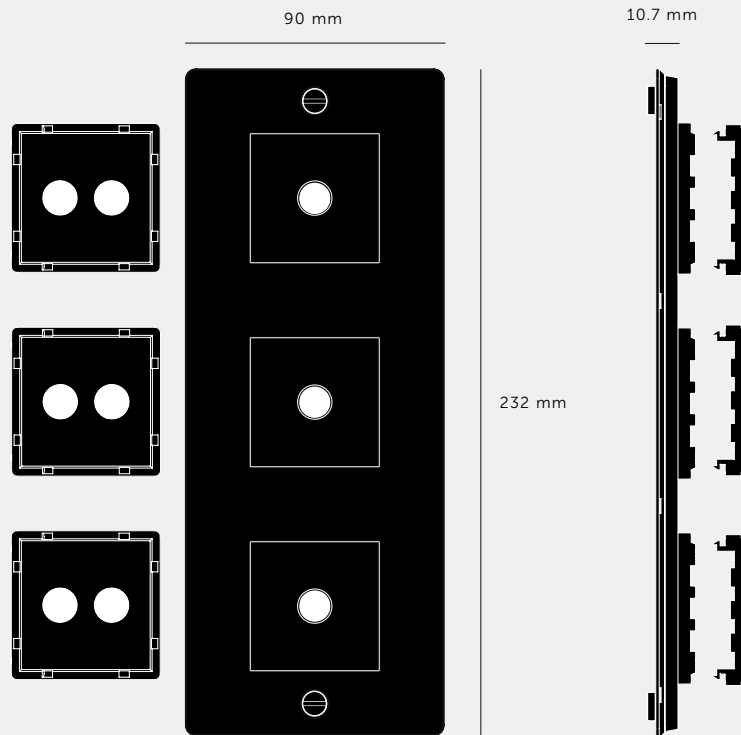

[info. **SPECIFICATIONS.**]

Each plate opening fits up to 2 switches / 1 dimmer / 1 power / 1 module insert.

*For white products, Socket & module inserts are finished in white. For all other finishes (steel, brass, smoked bronze, black), inserts are finished in black except for Swiss, Danish and Italian sockets, which are graphite.

[info. **RECOMMENDED.**]

3G back box - depth depending on module insert.

[info. **FINISH & SKU NUMBERS.**]

[finish.]	[sku.]
White	CPL-142395
Steel	CPL-072398
Brass	CPL-052397
Smoked Bronze	CPL-092399
Black	CPL-022396

[info. **CARE INSTRUCTIONS.**]

Wipe with damp cloth with no loose hairs, avoid using any chemicals. Please note that finishes may age naturally with time and regular use.

[please. **NOTE.**]

DISCLAIMER: Always consult a trade professional when installing this wall plate. Buster + Punch is not responsible for the usage or feasibility of installation requirements. This product is not suitable for damp or wet environments.

[type. **4G WALL PLATE.**]

[info. **MEASUREMENTS.**]

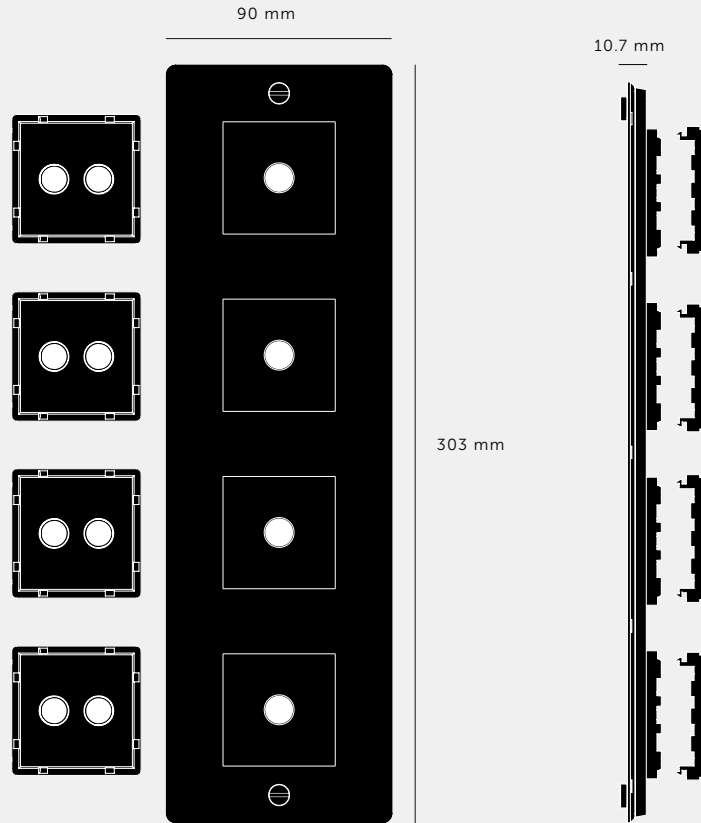

[info. **SPECIFICATIONS.**]

Each plate opening fits up to:-
2 switches / 1 dimmer / 1 power / 1 module insert.

*For white products, Socket & module inserts are finished in white. For all other finishes (steel, brass, smoked bronze, black), inserts are finished in black except for Swiss, Danish and Italian sockets, which are graphite.

[info. **RECOMMENDED.**]

Each plate opening fits up to:-
2 switches / 1 dimmer / 1 power / 1 module insert.

4G back box - depth depending on module insert.

[info. **CARE INSTRUCTIONS.**]

Wipe with damp cloth with no loose hairs, avoid using any chemicals. Please note that finishes may age naturally with time and regular use.

[info. **FINISH & SKU NUMBERS.**]

[finish.]	[sku.]
White	CPL-142400
Steel	CPL-072403
Brass	CPL-052402
Smoked Bronze	CPL-092404
Black	CPL-022401

[please. **NOTE.**]

DISCLAIMER: Always consult a trade professional when installing this wall plate. Buster + Punch is not responsible for the usage or feasibility of installation requirements. This product is not suitable for damp or wet environments.

BUSTER+PUNCH

LONDON

[product.]

WALL PLATES / NO INFILL

[detail. **COIN SCREW.**]

[range. **ELECTRICITY.**]

[born. **LONDON.**]

EU Plates are made in a variety of finishes with our signature solid metal coin screws. EU plates can be combined with module inserts to suit all your electrical, data, sound & AV needs. Module inserts can be purchased separately.



[type. **1G WALL PLATE / NO INFILL.**]

[info. **MEASUREMENTS.**]

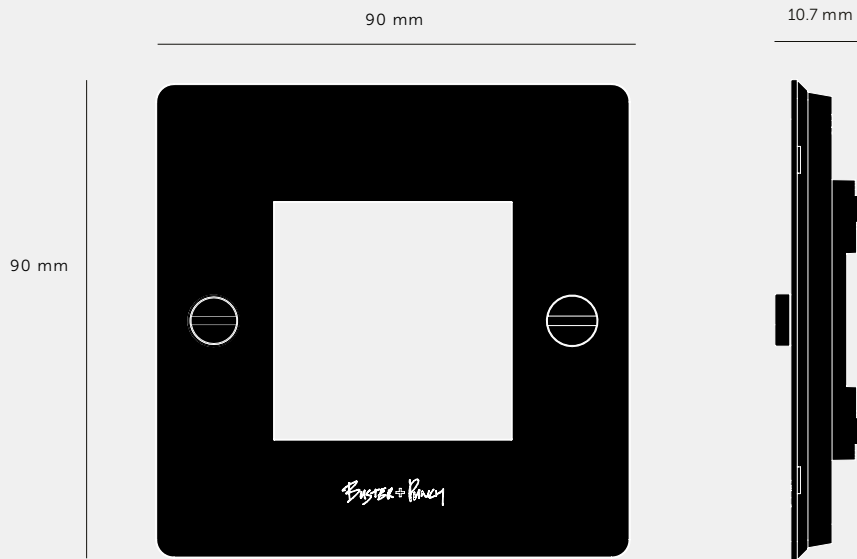

[info. **SPECIFICATIONS.**]

Each plate fits 1 power / 1 module insert.

*For white products, Socket & module inserts are finished in white. For all other finishes (steel, brass, smoked bronze, black), inserts are finished in black except for Swiss, Danish and Italian sockets, which are graphite.

[info. **RECOMMENDED.**]

1G back box - depth depending on module insert.

[info. **FINISH & SKU NUMBERS.**]

[finish.]	[sku.]
● White	CPL-142009
● Steel	CPL-072012
● Brass	CPL-052011
● Smoked Bronze	CPL-092013
● Black	CPL-022010

[info. **CARE INSTRUCTIONS.**]

Wipe with damp cloth with no loose hairs, avoid using any chemicals. Please note that finishes may age naturally with time and regular use.

[please. **NOTE.**]

DISCLAIMER: Always consult a trade professional when installing this wall plate. Buster + Punch is not responsible for the usage or feasibility of installation requirements. This product is not suitable for damp or wet environments.

[type. **2G WALL PLATE / NO INFILL.**]

[info. **MEASUREMENTS.**]

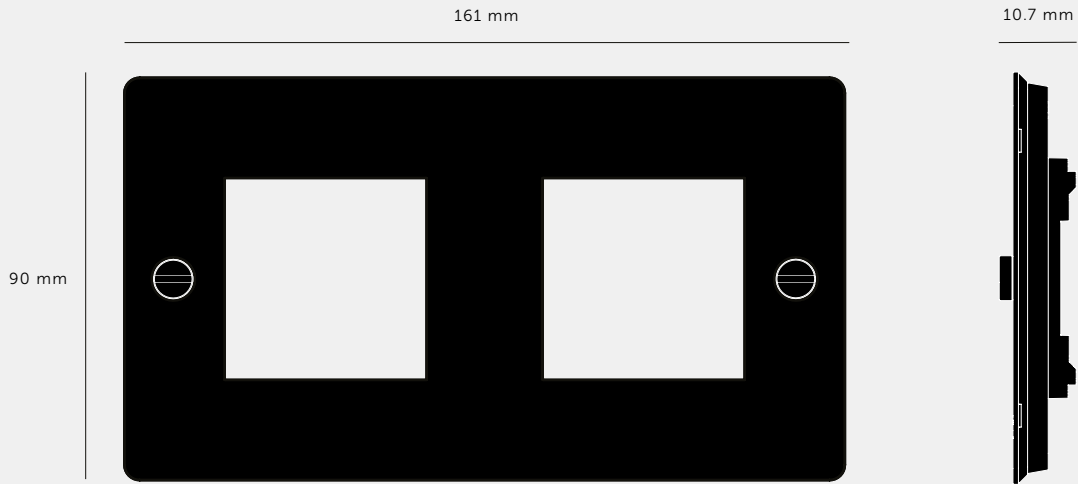

[info. **SPECIFICATIONS.**]





Each plate fits 1 power / 1 module insert.

*For white products, Socket & module inserts are finished in white. For all other finishes (steel, brass, smoked bronze, black), inserts are finished in black except for Swiss, Danish and Italian sockets, which are graphite.

[info. **RECOMMENDED.**]

Recommended back box:
2G back box - depth depending on module insert.

[info. **FINISH & SKU NUMBERS.**]

[finish.]	[sku.]
 White	CPL-142014
 Steel	CPL-072017
 Brass	CPL-052016
 Smoked Bronze	CPL-092018
 Black	CPL-022015

[info. **CARE INSTRUCTIONS.**]

Wipe with damp cloth with no loose hairs, avoid using any chemicals. Please note that finishes may age naturally with time and regular use.

[please. **NOTE.**]

DISCLAIMER: Always consult a trade professional when installing this wall plate. Buster + Punch is not responsible for the usage or feasibility of installation requirements. This product is not suitable for damp or wet environments.

[type. **3G WALL PLATE / NO INFILL.**]

[info. **MEASUREMENTS.**]

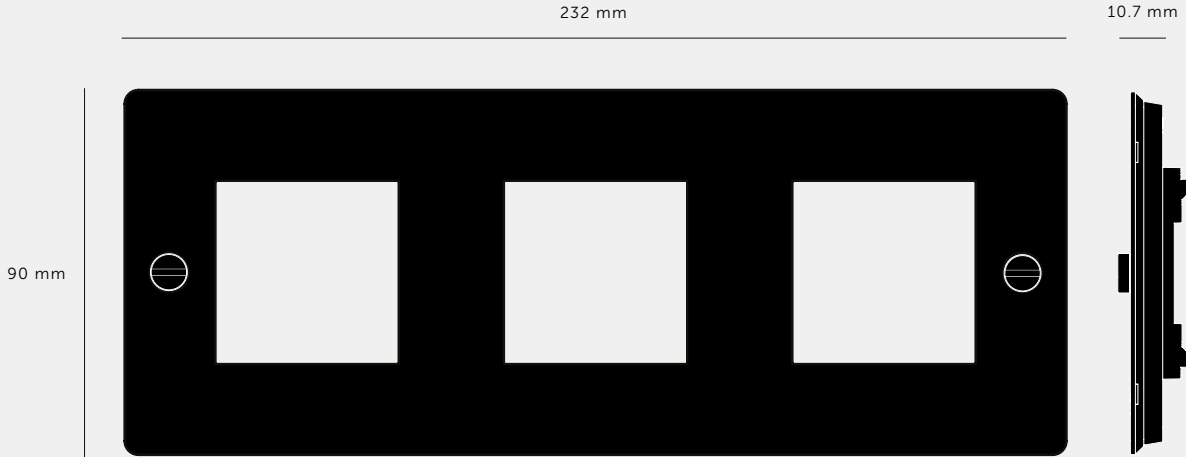

[info. **SPECIFICATIONS.**]





Each plate fits 1 power / 1 module insert.

*For white products, Socket & module inserts are finished in white. For all other finishes (steel, brass, smoked bronze, black), inserts are finished in black except for Swiss, Danish and Italian sockets, which are graphite.

[info. **SPECIFICATIONS.**]

3G back box - depth depending on module insert.

[info. **FINISH & SKU NUMBERS.**]

[finish.]	[sku.]
 White	CPL-142019
 Steel	CPL-072022
 Brass	CPL-052021
 Smoked Bronze	CPL-092023
 Black	CPL-022020

[info. **CARE INSTRUCTIONS.**]

Wipe with damp cloth with no loose hairs, avoid using any chemicals. Please note that finishes may age naturally with time and regular use.

[please. **NOTE.**]

DISCLAIMER: Always consult a trade professional when installing this wall plate. Buster + Punch is not responsible for the usage or feasibility of installation requirements. This product is not suitable for damp or wet environments.

[type. **4G WALL PLATE / NO INFILL.**]

[info. **MEASUREMENTS.**]

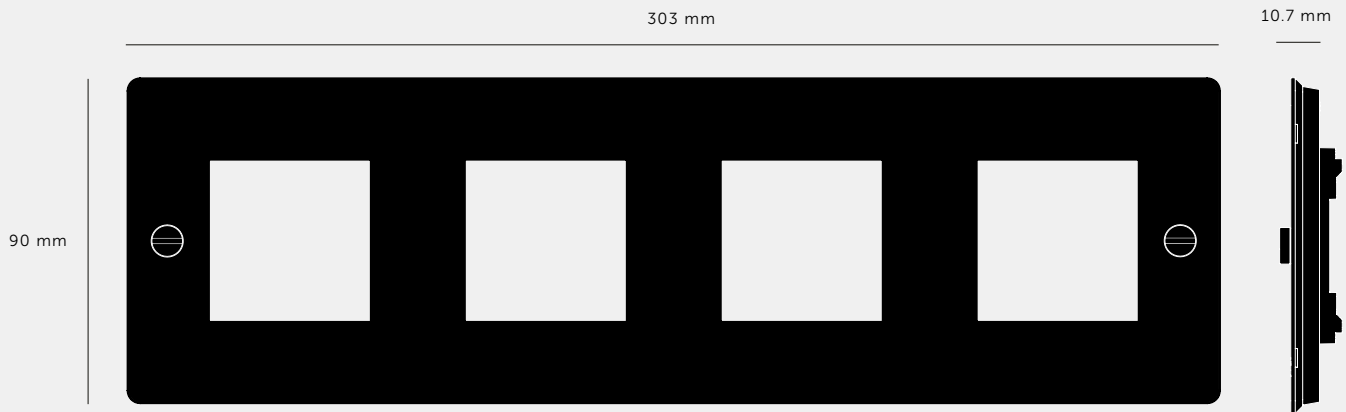

[info. **SPECIFICATIONS.**]





Each plate fits 1 power / 1 module insert.

*For white products, Socket & module inserts are finished in white. For all other finishes (steel, brass, smoked bronze, black), inserts are finished in black except for Swiss, Danish and Italian sockets, which are graphite.

[info. **SPECIFICATIONS.**]

4G back box - depth depending on module insert.

[info. **FINISH & SKU NUMBERS.**]

[finish.]	[sku.]
 White	CPL-142024
 Steel	CPL-072027
 Brass	CPL-052026
 Smoked Bronze	CPL-092028
 Black	CPL-022025

[info. **CARE INSTRUCTIONS.**]

Wipe with damp cloth with no loose hairs, avoid using any chemicals. Please note that finishes may age naturally with time and regular use.

[please. **NOTE.**]

DISCLAIMER: Always consult a trade professional when installing this wall plate. Buster + Punch is not responsible for the usage or feasibility of installation requirements. This product is not suitable for damp or wet environments.

CATEGORY	QUESTION	ANSWER
GENERAL	Can I combine different modules on the same plate?	Our plates are designed to accommodate a combination of modules, from 1G - 4G. Please refer to our website for purchasing options or contact one of our sales representatives for more information.
EU MODULES	What modules do you stock?	<p>We stock the following modules:</p> <p>CTM-142035 Toggle Switch / 2 way CTM-142036 Retractive Toggle Switch / 2 way CDM-012406 Dimmer Module / 120W LED / 2 way CDM-012405 Dimmer Module / 100W LED / 2 way CTM-142037 Intermediate Toggle Switch / 3 way CDM-142038 Dimmer Module / 250W LED / Retractive Multi Location CDM-142039 Dummy Dimmer / 2 way CDM-142040 Intermediate Dummy Dimmer / 3 way CDM-142041 1-10V Dimmer CSM-142029 Danish Socket Type K / White CSM-022032 Danish Socket Type K / Graphite Black CSM-142030 Swiss Socket Type J / White CSM-022033 Swiss Socket Type J / Graphite Black CSM-142031 Italian Multi Socket Type F + L / White CSM-022034 Italian Multi Socket Type F + L / Graphite Black CSM-141904 Schuko Socket Type F / White CSM-021896 Schuko Socket Type F / Black CSM-141905 France Belgium Socket / White CSM-021897 France Belgium Socket Type C + E / Black CXM-141906 USB A+ USB C Quick Charge / White CXM-021898 USB A+ USB C Quick Charge / Black CXM-141907 HDMI / White CXM-021899 HDMI / Black CXM-141908 Telephone Cat 3 / White CXM-021900 Telephone Cat 3 / Black CXM-141909 RJ45 / White CXM-021901 RJ45 / Black CXM-141910 TV / White CXM-021902 TV / Black CXM-141911 Blank / White CXM-021903 Blank / Black</p>
MODULES	If I can't find the module insert I want in your range what can I do?	Although we have tried to develop a widely compatible plate system, we cannot guarantee compatibility with other 45mm modules on the open market. Please discuss with a sales rep for special requirements
INSTALL	Will the plates work with my existing wall box?	Please reference the key dimensions of the module and mounting holes when checking compatibility. We always recommend flush mounted wall boxes, which are widely available from major retailers

[type. **SOCKET MODULES.**]

[info. **SPEC SHEET.**]

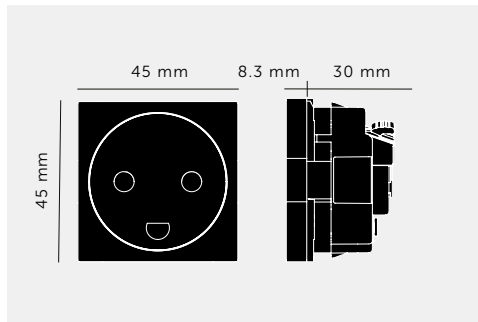

[Finish.]

[SKU.]

[info. **SPECIFICATION.**]

- White
- Graphite

CPL-142024
CSM-022032

DANISH SOCKET MODULE / TYPE K / 45MM

Outlet: 250VAC / 50Hz / 16A
Certification: DS 60884-2-D1:2017

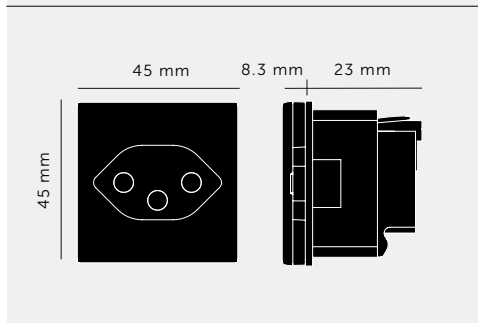

[Finish.]

[SKU.]

[info. **SPECIFICATION.**]

- White
- Graphite

CSM-142030
CSM-022033

SWISS SOCKET MODULE / TYPE 3 / 45MM

Outlet: 250VAC / 50Hz / 16A
Certified for use in Europe and Switzerland : CE

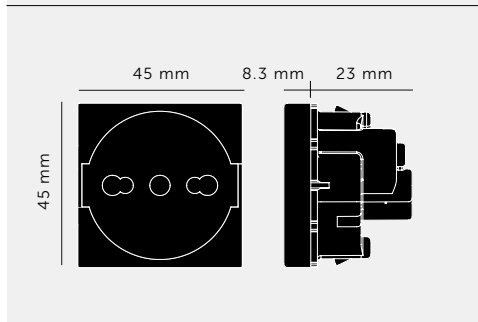

[Finish.]

[SKU.]

[info. **SPECIFICATION.**]

- White
- Graphite

CSM-142031
CSM-022034

ITALIAN MULTI SOCKET MODULE / TYPE F + L

Outlet: 250VAC / 50Hz / 16A
Certified for use in Europe : CE

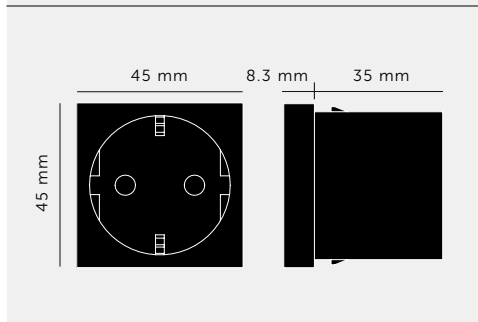

[Finish.]

[SKU.]

[info. **SPECIFICATION.**]

- White
- Black

CSM-141904
CSM-021896

SCHUKO SOCKET MODULE / TYPE F / 45MM

Outlet: 250VAC / 50Hz / 16A
Certified for use in: UK, Europe Russia: CE / EAC

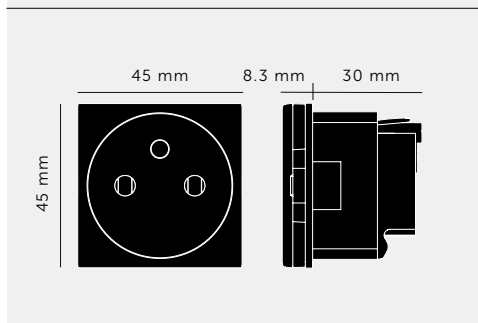

[Finish.]

[SKU.]

[info. **SPECIFICATION.**]

- White
- Black

CSM-141905
CSM-021897

FRENCH BELGIAN SOCKET MODULE / TYPE F / 45MM

Outlet: 250VAC / 50Hz / 16A
Certified for use in: UK, Europe Russia: CE / EAC

[info. **CARE INSTRUCTIONS.**]

Wipe with damp cloth with no loose hairs, avoid using any chemicals. All finishes are prone to ageing. Please note that finishes may age naturally with time and regular use.

[please. **NOTE.**]

DISCLAIMER: Always consult a trade professional when installing these modules. Buster + Punch is not responsible for the usage or feasibility of installation requirements. This product is not suitable for damp or wet environments.

[type. **MODULES.**]

[info. **SPEC SHEET.**]

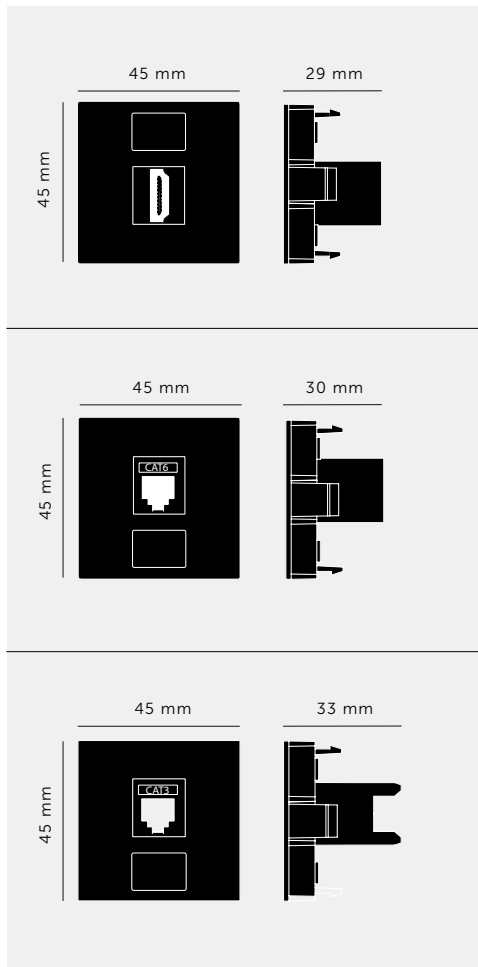

[Finish.]	[SKU.]	[info. SPECIFICATION.]
● White	CXM-141907	HDMI MODULE 45mm HDMI module
● Black	CXM-021899	

[Finish.]	[SKU.]	[info. SPECIFICATION.]
● White	CXM-141909	LAN MODULE / RJ45 / CAT6 Single RJ45 port for Cat 6 systems, standard IDC terminals, colour coded for 568B.
● Black	CXM-021901	

[Finish.]	[SKU.]	[info. SPECIFICATION.]
● White	CXM-141908	TELEPHONE MODULE / RJ11 / CAT 3 Single RJ11 port for CAT 3 systems
● Black	CXM-021900	

[please. **NOTE.**]

DISCLAIMER: Always consult a trade professional when installing these modules. Buster + Punch is not responsible for the usage or feasibility of installation requirements. This product is not suitable for damp or wet environments.

[type. **MODULES.**]

[info. **SPEC SHEET.**]

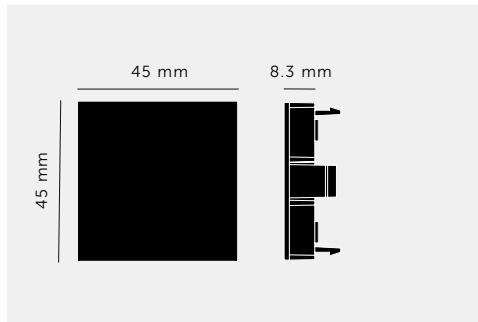

[Finish.]

[SKU.]

[info. **SPECIFICATION.**]

- White
- Black

CXM-141911
CXM-021903

BLANK MODULE
45mm blank module

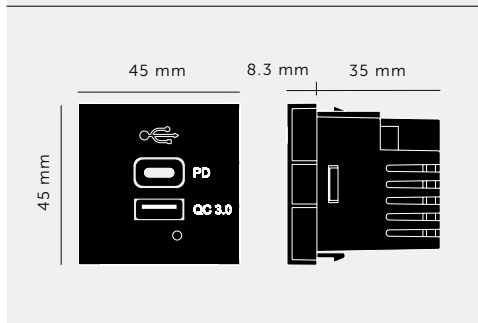

[Finish.]

[SKU.]

[info. **SPECIFICATION.**]

- White
- Black

CSM-142030
CXM-021898

USB MODULE / A + C QUICK CHARGE
USB Charger Type A + Type C: 5V 1.5A Each
Input: 100-250VAC 50/60Hz 0.5A
Output: 5VDC 3A, 9VDC 3A, 12VDC 2.5A, 15VDC 2A, 20VDC 1.5A
Total output power: 30W Max
No-load power consumption: 0.1W Max
Operating Temp & humidity: -10~+40 C 20%~90%RH
Certified for use in UK, Europe and Russia :
UKCA / CE / EAC

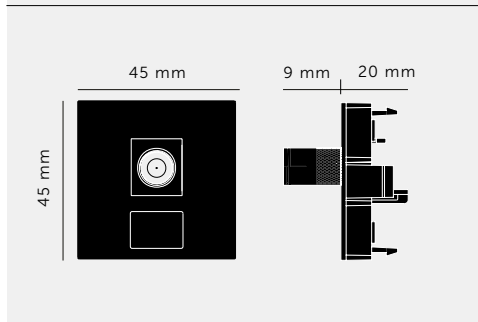

[Finish.]

[SKU.]

[info. **SPECIFICATION.**]

- White
- Black

CXM-141910
CXM-021902

TV MODULE / SAT / CABLE
TV/SAT - Female Type F Connector
Compatible with all Coaxial signal systems.

[please. **NOTE.**]

DISCLAIMER: Always consult a trade professional when installing these modules. Buster + Punch is not responsible for the usage or feasibility of installation requirements. This product is not suitable for damp or wet environments.

[type. **SWITCH MODULES.**]

[info. **SPEC SHEET.**]

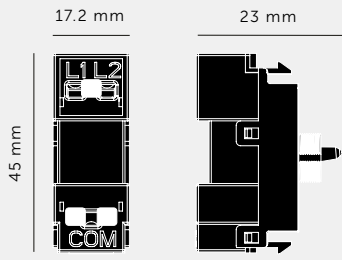
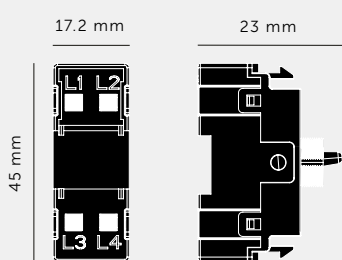
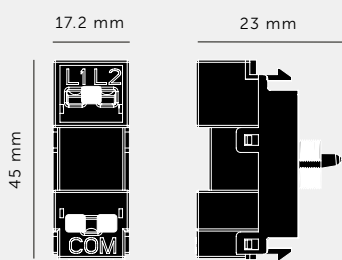
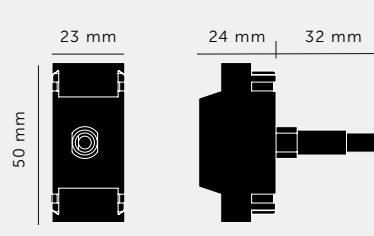
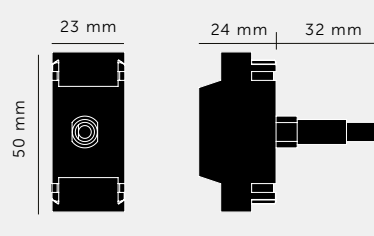
	<p>[Finish.] [SKU.] [info. SPECIFICATION.]</p> <p>● Black CTM-142035 TOGGLE SWITCH / 2 WAY</p> <p>On / Off Toggle Switch 2 Way switching (can be used to control from multiple locations) 250 VAC / 10 AX Certified for use in UK, Europe and Russia : UKCA / CE / EAC *Not compatible with retractive switching</p>
	<p>[Finish.] [SKU.] [info. SPECIFICATION.]</p> <p>● Black CTM-142037 INTERMEDIATE TOGGLE SWITCH / 3 WAY</p> <p>On / Off Toggle Switch 3 Way switching (can be controlled from multiple locations) 250 VAC / 10 AX Certified for use in UK, Europe and Russia : UKCA / CE / EAC *Not compatible with retractive switching</p>
	<p>[Finish.] [SKU.] [info. SPECIFICATION.]</p> <p>● Black CTM-142036 RETRACTIVE TOGGLE SWITCH / SINGLE THROW</p> <p>Single Throw 2 Way Sprung Return On / Off Toggle Switch 2 Way switching (can be controlled from multiple locations) 250 VAC / 10 A Certified for use in UK, Europe and Russia : UKCA / CE / EAC *Not compatible with regular 2-3 way switching</p>
	<p>[Finish.] [SKU.] [info. SPECIFICATION.]</p> <p>● Black CDM-142039 DIMMER MODULE / DUMMY / 2 WAY</p> <p>Push-On/Off 1-2 way switch in the form of a dimmer module for consistent styling 250VAC 6A</p> <p>Certified for use in UK, Europe and Russia : CE / EAC *Not compatible with retractive switching</p>
	<p>[Finish.] [SKU.] [info. SPECIFICATION.]</p> <p>● Black CDM-142040 DIMMER MODULE / INTERMEDIATE DUMMY / 3 WAY</p> <p>Push-On/Off 3-way Intermediate switch in the form of a dimmer module for consistent styling 250VAC 6A</p> <p>Certified for use in UK, Europe and Russia : CE / EAC *Not compatible with retractive switching</p>

[please. **NOTE.**]

DISCLAIMER: Always consult a trade professional when installing these modules. Buster + Punch is not responsible for the usage or feasibility of installation requirements. This product is not suitable for damp or wet environments.

[type. **DIMMER MODULES.**]

[info. **SPEC SHEET.**]

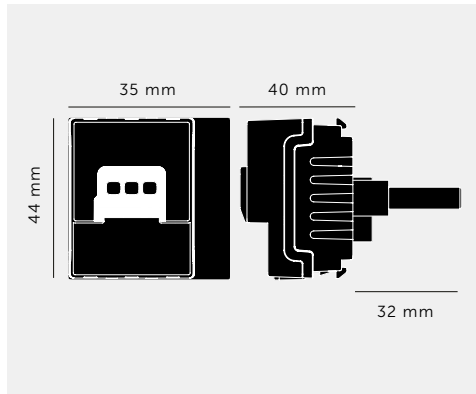

[Finish.]

[SKU.]

[info. **SPECIFICATION.**]

● Black

CDM-142038

DIMMER MODULE / 250W LED / RETRACTIVE MULTI-LOCATION

Push ON/OFF rotary dimmer with multi location dimming via retractive switches.
Input: 240VAC ~ 50Hz
Dimming Type:
Auto Detect Trailing / Leading Edge dimming
10-350W: When used with incandescent lamps
3-250W: When used with dimmable LED lamps.
Operating Temperature: 0-55 C Humidity: 10-90% R.H .
Certified for use in UK, Europe and Russia:
UKCA / CE / EAC
*Not compatible with regular 2-3 way switching

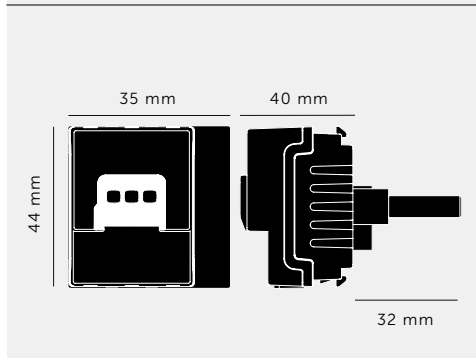

[Finish.]

[SKU.]

[info. **SPECIFICATION.**]

● Black

CDM-012405

DIMMER MODULE / 100W LED / 2 WAY

Push ON/OFF rotary dimmer with 1-2 way switching
Input: 240VAC ~ 50Hz
Compatible with regular 2-3 Way switches
Dimming Type: Trailing Edge dimming only
10-250W: When used with incandescent lamps
2-100W: When used with dimmable LED lamps.
Operating Temperature: 0-55 C Humidity: 10-90% R.H.
Certified for use in UK, Europe and Russia:
UKCA / CE / EAC
*Not compatible with retractive switching.

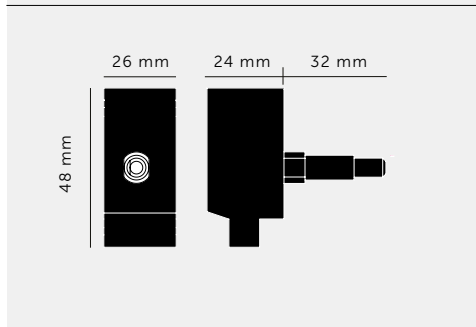

[Finish.]

[SKU.]

[info. **SPECIFICATION.**]

● Black

CDM-012406

DIMMER MODULE / 120W LED / 2 WAY

Push On/Off rotary dimmer with 1-2 way switching
Compatible with regular 2-3 Way switches
Preset to Trailing edge dimming
Programable to Leading / Trailing edge modes
LED 120W Max.Up to :
10 Bulbs/HAL 150W Max./GLS 200W Max.
250VAC / 50Hz
Certified for use in UK, Europe and Russia: CE / EAC
*Not compatible with retractive switching

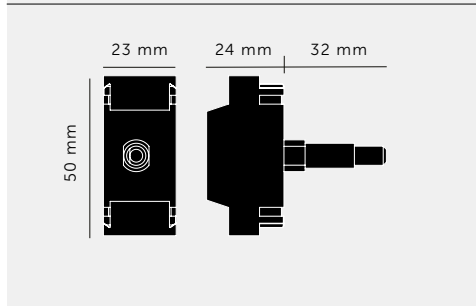

[Finish.]

[SKU.]

[info. **SPECIFICATION.**]

● Black

CDM-142041

DIMMER MODULE / 1-10V / 2 WAY

Push On/Off rotary dimmer with 1-2 way switching
0 - 10V or 1- 10V control signal.
Compatible with regular 2-3 Way switches
For one or multiple high frequency dimmable ballasts up to 20mA.
Rated at 250VAC 6A Max.
Certified for use in UK, Europe and Russia: CE / EAC
*Not compatible with retractive switching

[please. **NOTE.**]

DISCLAIMER: Always consult a trade professional when installing these modules. Buster + Punch is not responsible for the usage or feasibility of installation requirements. This product is not suitable for damp or wet environments.

[type. **BACK BOXES.**]

[info. **SPEC SHEET.**]

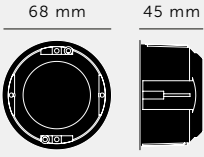
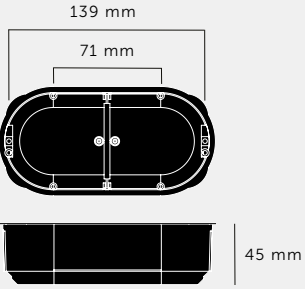
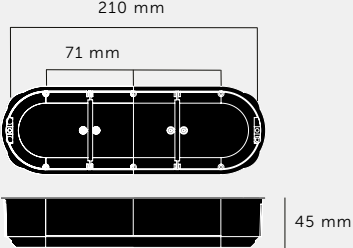
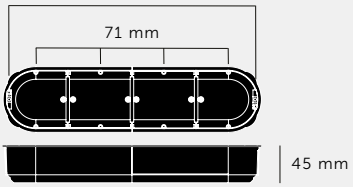
	<table border="1"><thead><tr><th>[size.]</th><th>[SKU.]</th><th>[info. SPECIFICATION.]</th></tr></thead><tbody><tr><td>1G</td><td>CSC-012652</td><td>Junction box for cavity walls. Style: EU Plastic Back Box Hole saw diameter 68mm Mounting screws: W16, W25, W42 Operating Temperature: 60°C Fire protection class V0 Blue thermoplastic material PA6 Conforms to relevant CE standards</td></tr></tbody></table>	[size.]	[SKU.]	[info. SPECIFICATION.]	1G	CSC-012652	Junction box for cavity walls. Style: EU Plastic Back Box Hole saw diameter 68mm Mounting screws: W16, W25, W42 Operating Temperature: 60°C Fire protection class V0 Blue thermoplastic material PA6 Conforms to relevant CE standards
[size.]	[SKU.]	[info. SPECIFICATION.]					
1G	CSC-012652	Junction box for cavity walls. Style: EU Plastic Back Box Hole saw diameter 68mm Mounting screws: W16, W25, W42 Operating Temperature: 60°C Fire protection class V0 Blue thermoplastic material PA6 Conforms to relevant CE standards					
	<table border="1"><thead><tr><th>[size.]</th><th>[SKU.]</th><th>[info. SPECIFICATION.]</th></tr></thead><tbody><tr><td>2G</td><td>CSC-012653</td><td>Junction box for cavity walls. Style: EU Plastic Back Box Hole saw diameter 68mm Mounting screws: W16, W25, W42 Operating Temperature: 60°C Fire protection class V0 Blue thermoplastic material PA6 Conforms to relevant CE standards</td></tr></tbody></table>	[size.]	[SKU.]	[info. SPECIFICATION.]	2G	CSC-012653	Junction box for cavity walls. Style: EU Plastic Back Box Hole saw diameter 68mm Mounting screws: W16, W25, W42 Operating Temperature: 60°C Fire protection class V0 Blue thermoplastic material PA6 Conforms to relevant CE standards
[size.]	[SKU.]	[info. SPECIFICATION.]					
2G	CSC-012653	Junction box for cavity walls. Style: EU Plastic Back Box Hole saw diameter 68mm Mounting screws: W16, W25, W42 Operating Temperature: 60°C Fire protection class V0 Blue thermoplastic material PA6 Conforms to relevant CE standards					
	<table border="1"><thead><tr><th>[size.]</th><th>[SKU.]</th><th>[info. SPECIFICATION.]</th></tr></thead><tbody><tr><td>3G</td><td>CSC-012654</td><td>Junction box for cavity walls. Style: EU Plastic Back Box Hole saw diameter 68mm Mounting screws: W16, W25, W42 Operating Temperature: 60°C Fire protection class V0 Blue thermoplastic material PA6 Conforms to relevant CE standards</td></tr></tbody></table>	[size.]	[SKU.]	[info. SPECIFICATION.]	3G	CSC-012654	Junction box for cavity walls. Style: EU Plastic Back Box Hole saw diameter 68mm Mounting screws: W16, W25, W42 Operating Temperature: 60°C Fire protection class V0 Blue thermoplastic material PA6 Conforms to relevant CE standards
[size.]	[SKU.]	[info. SPECIFICATION.]					
3G	CSC-012654	Junction box for cavity walls. Style: EU Plastic Back Box Hole saw diameter 68mm Mounting screws: W16, W25, W42 Operating Temperature: 60°C Fire protection class V0 Blue thermoplastic material PA6 Conforms to relevant CE standards					
	<table border="1"><thead><tr><th>[size.]</th><th>[SKU.]</th><th>[info. SPECIFICATION.]</th></tr></thead><tbody><tr><td>4G</td><td>CSC-012655</td><td>Junction box for cavity walls. Style: EU Plastic Back Box Hole saw diameter 68mm Mounting screws: W16, W25, W42 Operating Temperature: 60°C Fire protection class V0 Blue thermoplastic material PA6 Conforms to relevant CE standards</td></tr></tbody></table>	[size.]	[SKU.]	[info. SPECIFICATION.]	4G	CSC-012655	Junction box for cavity walls. Style: EU Plastic Back Box Hole saw diameter 68mm Mounting screws: W16, W25, W42 Operating Temperature: 60°C Fire protection class V0 Blue thermoplastic material PA6 Conforms to relevant CE standards
[size.]	[SKU.]	[info. SPECIFICATION.]					
4G	CSC-012655	Junction box for cavity walls. Style: EU Plastic Back Box Hole saw diameter 68mm Mounting screws: W16, W25, W42 Operating Temperature: 60°C Fire protection class V0 Blue thermoplastic material PA6 Conforms to relevant CE standards					

[please. **NOTE.**]

DISCLAIMER: Always consult a trade professional when installing these modules. Buster + Punch is not responsible for the usage or feasibility of installation requirements. This product is not suitable for damp or wet environments.



BUSTER + PUNCH

EU ELECTRICITY

SALES ENQUIRIES

info@busterandpunch.com

FOLLOW US

twitter: [@busterandpunch](https://twitter.com/busterandpunch)

instagram: [@busterandpunch](https://www.instagram.com/busterandpunch)

facebook: [busterandpunch](https://www.facebook.com/busterandpunch)

BUSTER + PUNCH / LONDON

The Hop Exchange Suites 7-9

24 Southwark Street

London, SE1 1TY

+44 (0)20 7407 0888

london@busterandpunch.com

BUSTER + PUNCH / STOCKHOLM

Artillerigatan 25

114 45

Stockholm

+46 (0)76 577 46 50

stockholm@busterandpunch.com