

# SLIDE

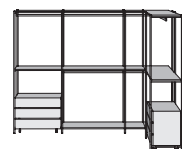

LE COPPIE DI PROFILI VERTICALI, I RIIPIANI E LE BARRE APPENDERIA SONO ORDINABILI AL CENTIMETRO, CIÒ CONSENTE DI PROGETTARE LO SPAZIO DESIDERATO IN MODO SARTORIALE SENZA EXTRACOSTI DI RIDUZIONI.

The pairs of upright profiles, the shelves and hanging rails can be sized to the centimetre, making it possible to design a tailor-made space without the added cost of reductions.

Les paires de profils verticaux, les étagères et les barres porte-vêtements peuvent être commandées au centimètre, ceci permet d'organiser l'espace souhaité « sur mesure » sans coûts supplémentaires de réduction.

Die Paare vertikaler Profile, die Böden und die Aufhängestangen können zentimetergenau bestellt werden. Dadurch kann der gewünschte Raum ohne zusätzliche Kosten für Kürzungen maßgeschneidert geplant werden.

Los pares de perfiles verticales, estantes y barras de colgar se pueden pedir por centímetros, lo que permite diseñar el espacio deseado adaptándolos sin costos adicionales de reducción.

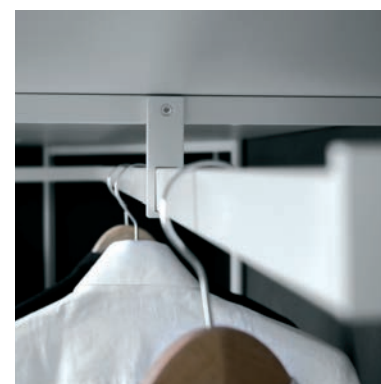
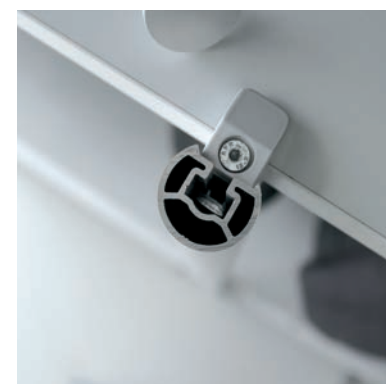

## PRODUCT CONCEPT

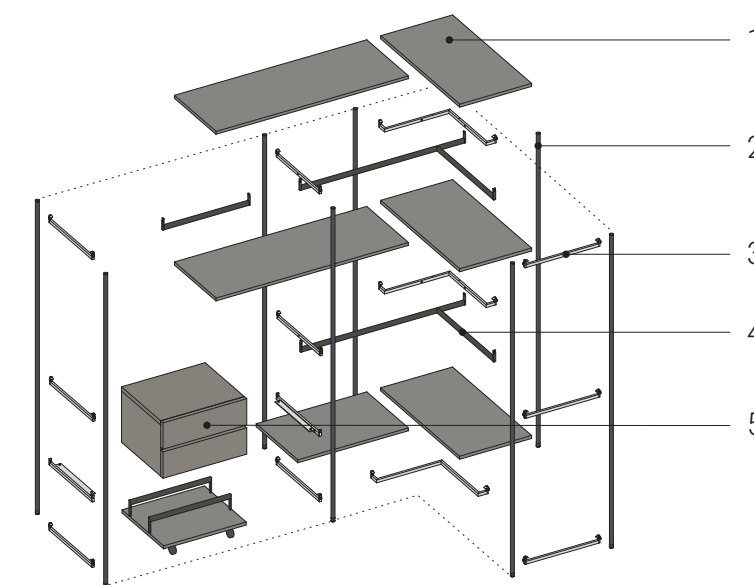

L  
61.5 - 91.5 - 121.5

H  
riducibile al centimetro  
reducible to the centimetre  
réductible au centimètre  
verkürzbar auf den Zentimeter  
reducible al centímetro

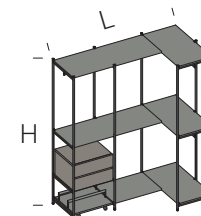

Ripiani e contenitori hanno libera posizione in altezza, (al centimetro).  
Shelves and containers can be positioned at any height (to the centimetre).  
Les étagères et les conteneurs peuvent être positionnés librement en hauteur (au centimètre près).  
Einlegeböden und Behälter sind in der Höhe frei einsetzbar (auf den Zentimeter).  
Los estantes y los contenedores tienen una posición de altura libre (al centimetro).

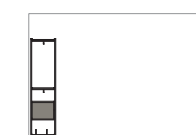

Pavimento / parete  
Floor / wall  
Sol / mur  
Boden / Wand  
Suelo / pared

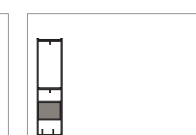

Pavimento / bifacciale  
Floor / Double-sided  
Sol / Double face  
Boden / Zweiseitig  
Suelo / Doble cara



Riduzioni a misura disponibili su profili verticali, ripiani e barre appendieria.  
Measurement reductions available on vertical profiles, shelves and hanging rails.  
Réductions sur mesure possibles sur les profilés verticaux, les étagères et les barres de penderie.  
Verkürzungen nach Kundenwunsch für vertikale Profile, Einlegeböden und Aufhängestangen verfügbar.  
Reducciones de tamaño disponibles en perfiles verticales, estantes y barras de colgar.



1

I ripiani sono continui e riducibili al centimetro, il sistema di ancoraggio a pinza tra ripiano e nodo consente il libero posizionamento in verticale ed orizzontale.

The shelves are continuous and reducible to a centimetre, the clamp anchoring system between the shelf and node allows free positioning both vertically and horizontally.

Les étagères sont continues et peuvent être réduites au centimètre près ; le système d'ancrage par pince entre l'étagère et le nœud permet un libre positionnement à la verticale ou à l'horizontale.

Die Einlegeböden sind durchlaufend und auf den Zentimeter verkürzbar, das Klemmen-Verankerungssystem zwischen Boden und Knotenpunkt ermöglicht die freie Positionierung, vertikal und horizontal.

Los estantes son continuos y pueden reducirse al centimetro. El sistema de sujeción entre el estante y el nodo permite un posicionamiento vertical y horizontal libre.



3

I nodi con funzione di supporto ed unione tra coppie di profili verticali e ripiani, sono in acciaio.

The nodes, that support and join couples of vertical profiles and shelves, are made of steel.

Les nœuds, avec fonction de support et d'union entre les paires de profilés verticaux et les étagères, sont en acier.

Die Knotenpunkte dienen als Stütze und Verbindung zwischen vertikalen Profilaaren und Einlegeböden und sind aus Stahl.

Los nudos que soportan y unen los pares de perfiles verticales y los estantes son de acero.



2

Le coppie di profili verticali sono in alluminio estruso con sezione circolare diametro 25 mm. La finitura viene eseguita con verniciatura a polveri a 180°.

The pairs of vertical profiles are made of extruded aluminium with circular section, diameter 25 mm. 180° powder coating finish.

Les paires de profilés verticaux sont en aluminium extrudé à section circulaire de 25 mm de diamètre. Les finitions sont réalisées avec peinture à poudre à 180°.

Die vertikalen Profilaare sind aus extrudiertem Aluminium mit kreisförmigem Querschnitt und einem Durchmesser von 25 mm. Die Beschichtung wird durch Pulverlackieren bei 180° ausgeführt.

Los pares de perfiles verticales son de aluminio extruido con un diámetro de sección circular de 25 mm. Están acabados con un revestimiento de polvo a 180°.



4

Le barre appendieria sono in alluminio verniciato a polveri a 180°. Esse sono indipendenti dai ripiani e sono ancorate al nodo in acciaio garantendo un'ottima resistenza ai carichi.

The hanging rails are in 180° powder coated aluminium. They are independent from the shelves and are anchored to the steel node, guaranteeing excellent resistance to loads.

Les barres de penderie sont en aluminium peint à la poudre à 180°. Elles sont indépendantes des étagères et ancrées au nœud en acier, permettant ainsi une excellente résistance aux charges.

Die Aufhängestangen sind aus 180°-pulverlackiertem Aluminium. Sie sind von den Böden unabhängig und sind mit dem Knotenpunkt aus Stahl verankert und gewährleisten so eine optimale Belastbarkeit.

Las barras de suspensión son de aluminio, con recubrimiento de polvo a 180°. Son independientes de las estanterías y se anclan al nudo de acero, garantizando una excelente resistencia a las cargas.



5

Le cassettiere a modulo 61.5/91.5/121.5 cm a 2/3/4/6 cassetti, sono disponibili in finitura melaminica e laccato. Sono disponibili in versione su ruote o sospese.

The 61.5/91.5/121.5 cm module chests of drawers with 2/3/4/6 drawers, are available in melamine and lacquered finish. They are available with wheels or in the suspended version.

Les blocs tiroirs 61,5/91,5/121,5 cm avec 2/3/4/6 tiroirs sont disponibles avec finitions en mélamine et laquées. Ils sont disponibles en versions à roulettes ou suspendues.

Die Modul-Schubladenschränke 61.5/91.5/121.5 cm mit 2/3/4/6 Schubladen sind mit den Beschichtungen Melamin und lackiert verfügbar. Sie sind in den Versionen auf Rädern oder aufgehängt verfügbar.

Las cajoneras modulares de 61,5/91,5/121,5 cm con 2/3/4/6 cajones están disponibles en acabado melamina y lacado. Están disponibles en versión con ruedas o suspendidas.

## FINITURE/FINISHES

### spalle / support profiles

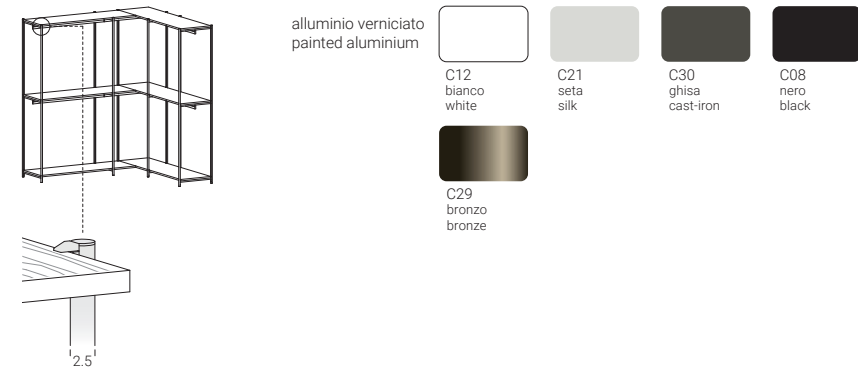

## DIMENSIONI/DIMENSIONS

verificare a listino dimensioni e finiture  
check dimensions and finishes in the price list

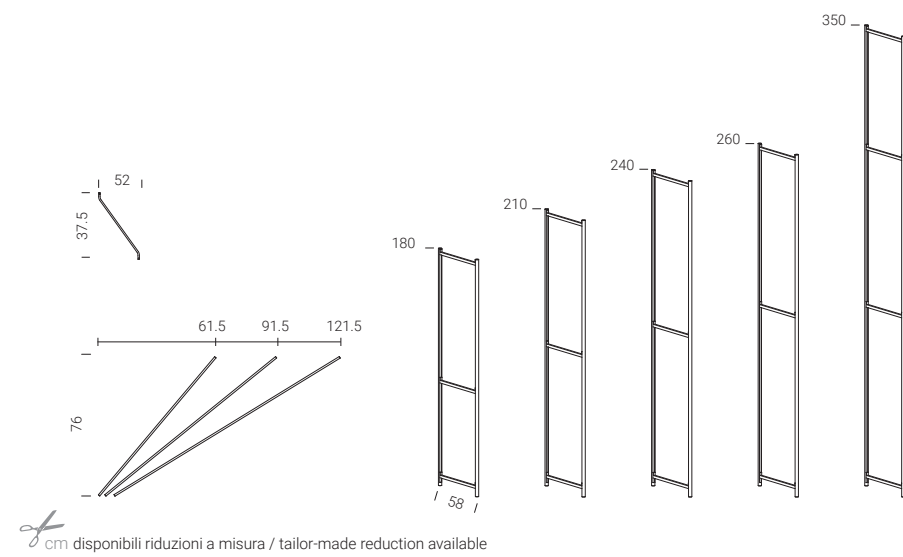

## FINITURE/FINISHES

### contenitori / cabinets

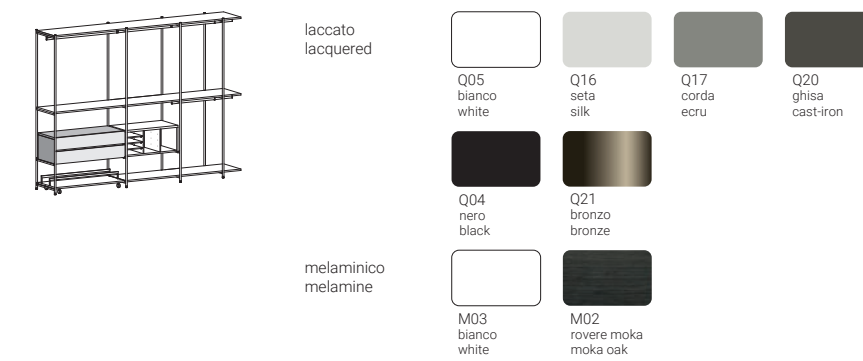

## DIMENSIONI/DIMENSIONS

verificare a listino dimensioni e finiture  
check dimensions and finishes in the price list

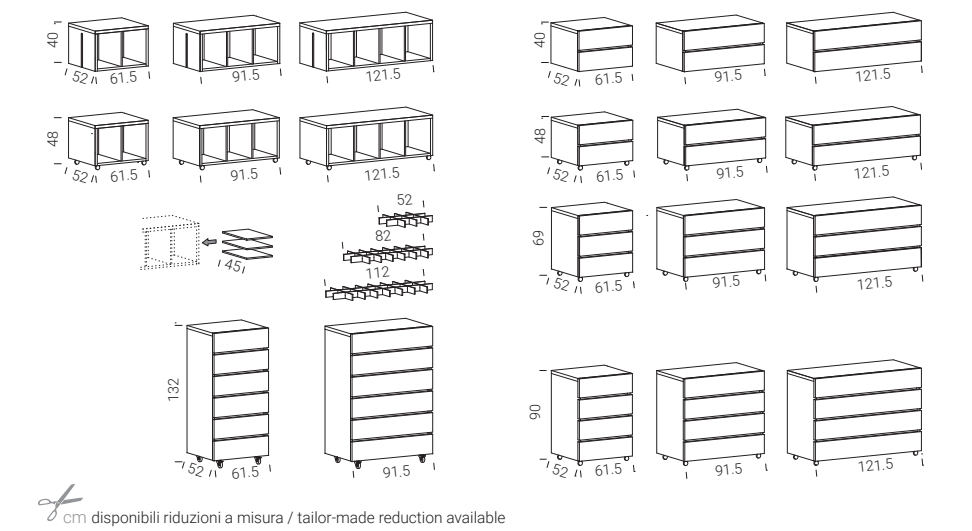

### ripiani in agglomerato ligneo / wood composite shelves

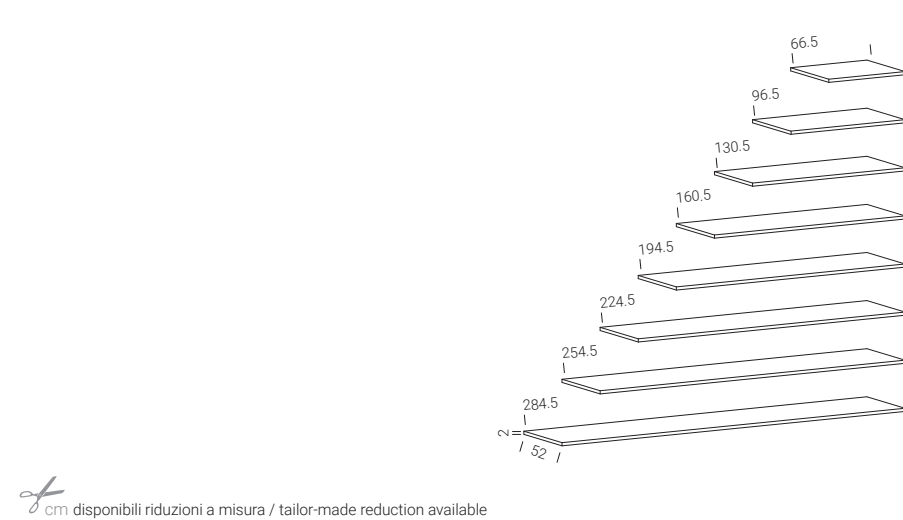
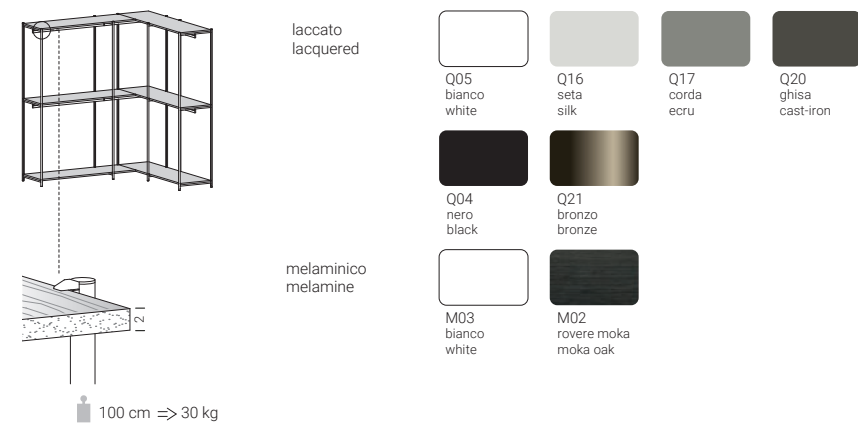

### ripiani portascarpe su ruote / shoe rack shelves on casters

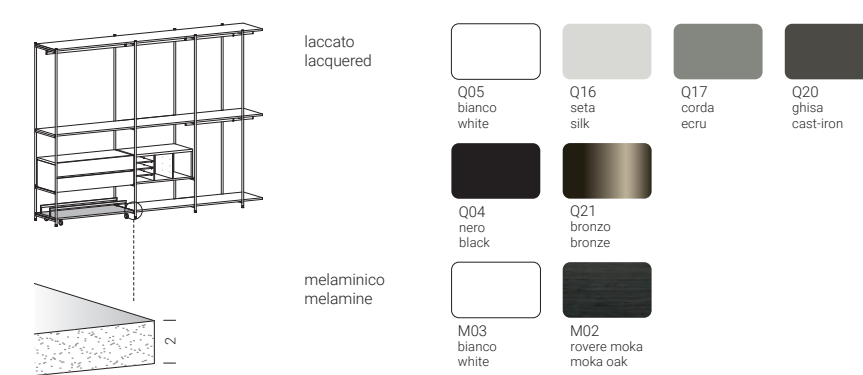

### barre portabiti / clothes rails

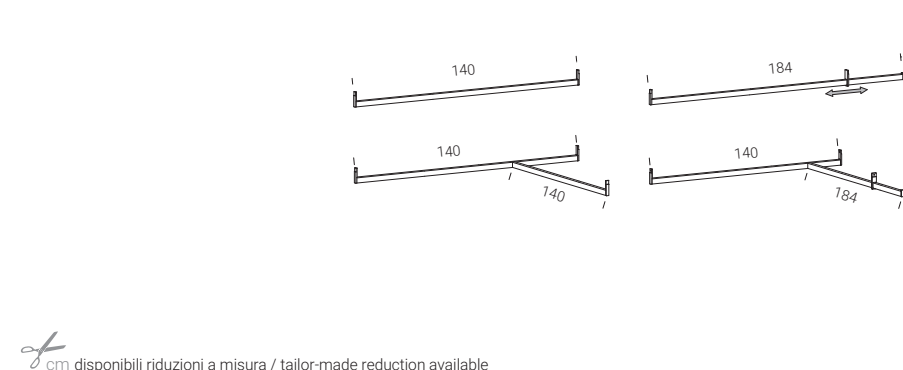

### portapantaloni / trouser rail

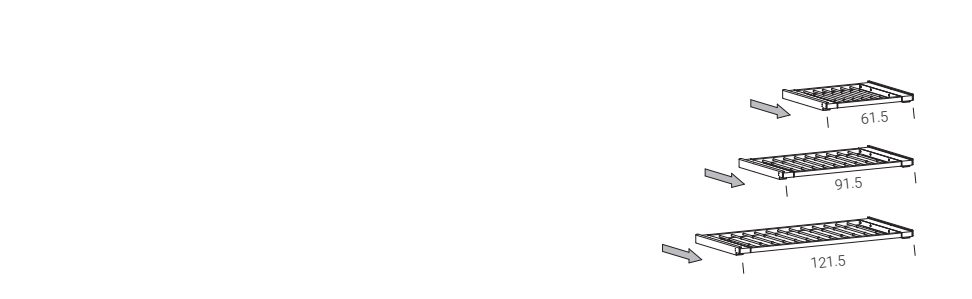



01/SLIDE

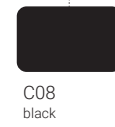
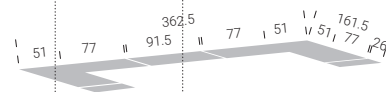
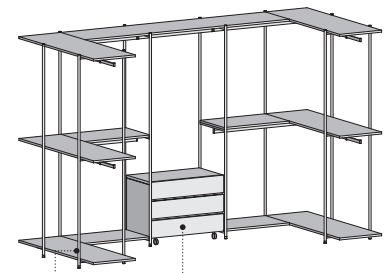

C08  
black



M02  
moka oak









04/SLIDE

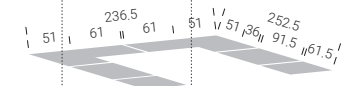
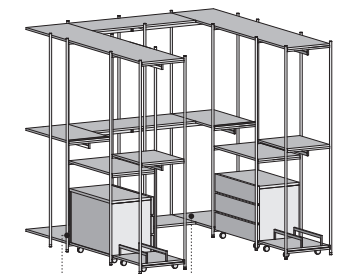

C12  
white

M03  
white









03/SLIDE

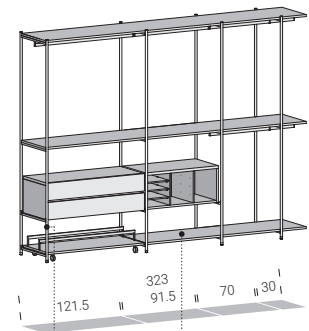

C21  
silk

Q17  
ecru





02/SLIDE

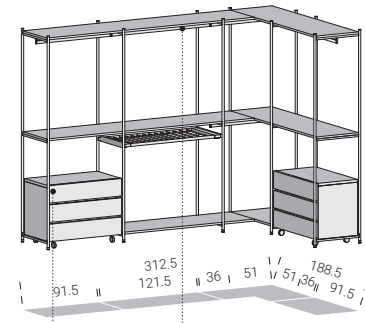

M03  
white

C12  
white



MR. HYDE pg. 270

