

# EWS

extendo wall system



UN SISTEMA LIVING DALLE MOLTEPLICI  
POSSIBILITÀ DI INSTALLAZIONE: SOSPESO A  
PARETE, CON APPOGGIO A PAVIMENTO, DA  
PAVIMENTO A SOFFITTO ED AUTOPORTANTE.  
I PROFILI VERTICALI CONSENTONO IL  
POSIZIONAMENTO IN ALTEZZA DI CONTENITORI  
E RIPIANI AL CENTIMETRO. I PANNELLI  
DI RIVESTIMENTO UTILIZZATI ANCHE  
PARZIALMENTE POSSONO ESSERE RIMOSSI  
AGEVOLMENTE PER POTER ACCEDERE AI CAVI  
DI TV, IMPIANTI AUDIO, LAMPADE.

A living system with multiple installation possibilities: suspended on the wall, with or without floor support, floor standing, wall mounting and free standing. The vertical profiles permit positioning of containers and shelves to the centimetre. Any panels used can be easily removed to access TV, audio systems and lamp cables.

Un système pour salon avec de multiples possibilités d'installation : suspendu au mur, avec ou sans support au sol, du sol au plafond et autoporteur. Les profils verticaux permettent de positionner les conteneurs et les étagères en hauteur, au centimètre près. Les panneaux d'embellissement utilisés, même partiellement, peuvent être facilement retirés pour accéder aux câbles des téléviseurs, systèmes audios, lampes.

Ein Living-System mit zahlreichen Montage-Möglichkeiten: hängend an der Wand, sowohl mit als auch ohne Stütze auf dem Boden, vom Boden bis zur Decke und selbsttragend. Die vertikalen Profile ermöglichen die Positionierung auf den Zentimeter der Behälter und der Einlegeböden. Die auch zum Teil verwendeten Überzugplatten können leicht entfernt werden, um zu den Kabeln von TV, Audioanlagen, Lampen zu greifen.

Un sistema con múltiples posibilidades de instalación: colgado en la pared, con o sin soporte en el suelo, de suelo a techo y autónomo. Los perfiles verticales permiten posicionar en altura los contenedores y las estanterías con una precisión de un centímetro. Los paneles de recubrimiento utilizados parcial o totalmente pueden retirarse fácilmente para acceder a los cables de la televisión, los sistemas de audio y las lámparas.

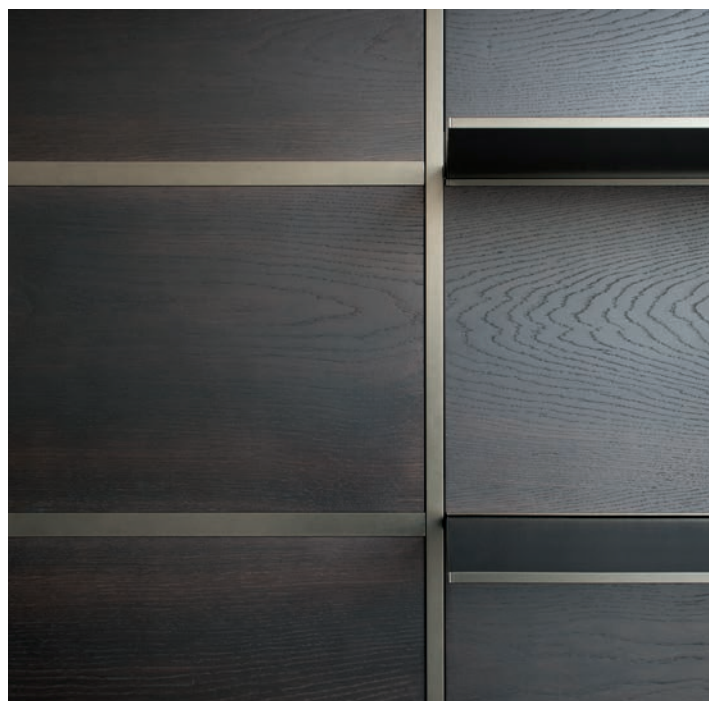

## PRODUCT CONCEPT

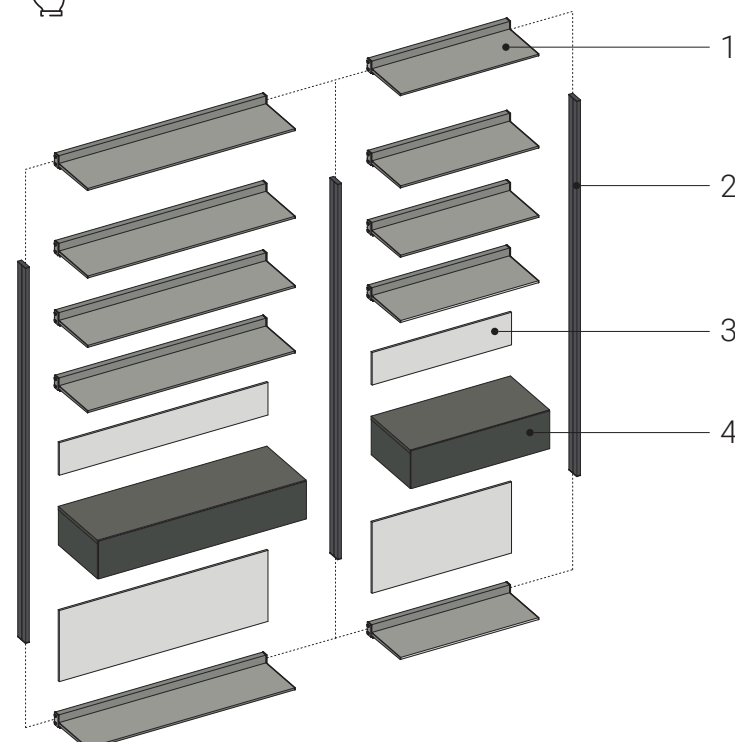

L modules  
36 - 72.5 - 108.5 - 144.5

H modules  
reducibile al centimetro  
reducible to the centimetre  
réductible au centimètre  
verkürzbar auf den  
Zentimeter  
reducible al centimetro

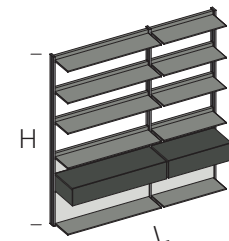

Ripiani e contenitori hanno libera posizione in altezza, (al centimetro).

Shelves and containers can be positioned at any height (to the centimetre).

Les étagères et les conteneurs peuvent être positionnés librement en hauteur (au centimètre près).

Einlegeböden und Behälter sind in der Höhe frei einsetzbar (auf den Zentimeter).

Los estantes y contenedores tienen una altura libre (al centímetro).



Sospeso a parete  
Wall suspended  
Suspendu au mur  
An der Wand hängend  
Montado en la pared

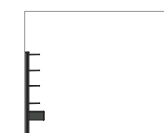

Pavimento / parete  
Floor / wall  
Sol/mur  
Boden / Wand  
Suelo / pared

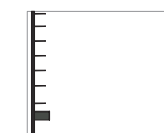

Pavimento / soffitto  
Floor / ceiling  
Sol/plafond  
Boden / Decke  
Suelo/techo

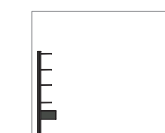

Appoggio a pavimento  
Floor standing  
Appui au sol  
Auf den Boden stützend  
Apoyado al suelo



Riduzioni a misura disponibili su profili verticali, ripiani e pannelli rivestimento.  
Measurement reductions available on vertical profiles, shelves and panels.

Réductions sur mesure possibles sur les profils verticaux, les étagères et les panneaux de revêtement.

Verkürzung nach Kundenwunsch auf vertikalen Profilen, Einlegeböden und Verkleidungsplatten.  
Las reducciones de tamaño son posibles en los perfiles verticales, las repisas y los paneles de revestimiento.



Passacavi disponibili su pannelli rivestimento e contenitori  
Cable sleeves available on panels and containers

Passe-câbles disponibles sur les panneaux de revêtement et les conteneurs.

Kabeldurchgänge auf Verkleidungsplatten und Behälter verfügbar  
Pasacables disponibles en los paneles de revestimiento y en los contenedores



Barre LED integrate ai pannelli rivestimento  
LED light bars incorporated in the panels

Barres LED incorporées dans les panneaux de revêtement  
In den Verkleidungsplatten integrierte LED-Stangen  
Barras de LED integradas en los paneles de revestimiento



1

I ripiani in alluminio estruso sono stati progettati in ogni minimo dettaglio per ottenere le massime performance di resistenza al carico con il minimo impiego di materiale.

Each and every detail of the extruded aluminium shelves has been designed to achieve maximum load resistance with the minimum amount of material.

Les étagères en aluminium extrudé ont été conçues dans les moindres détails pour obtenir des performances de résistance à la charge maximum en utilisant le moins de matériau possible.

Die Einlegeböden aus extrudiertem Aluminium wurden in jedem kleinsten Detail entworfen, um die höchste Belastbarkeit bei der niedrigsten Menge an verwendetem Material zu erhalten.

Los estantes de aluminio extruido se han diseñado hasta el más mínimo detalle para lograr el máximo rendimiento de carga con el mínimo uso de material.



2

I profili verticali in alluminio estruso, sono configurabili per adattarsi alle diverse esigenze degli ambienti. Sono infatti possibili configurazioni per l'installazione a parete, pavimento, soffitto e autoportante.

The vertical extruded aluminium profiles are modular, to adapt to the spaces. Indeed, they can be wall, floor or ceiling mounted or self-standing.

Les profils verticaux en aluminium extrudé peuvent être configurés pour s'adapter aux différents besoins des espaces. Des configurations pour une installation au mur, au sol, au plafond et autoportante sont ainsi possibles.

Die Vertikalen Profile aus extrudiertem Aluminium sind gestaltbar, um sich an die verschiedenen Anforderungen der Räume anzupassen. Es sind nämlich Konfigurationen für die Montage an der Wand, auf dem Boden, an der Decke und selbsttragende Konfigurationen möglich.

Los perfiles verticales de aluminio extruido pueden configurarse para adaptarse a los diferentes requisitos de los entornos. Las configuraciones son posibles para la instalación en la pared, en el suelo, en el techo y de forma independiente.



3

I pannelli schiena in MDF, disponibili in essenza e laccato, consentono il rivestimento della composizione parzialmente o totalmente, arricchendo la parete ed occultando eventuali cavi elettrici.

The MDF back panels, available in wood or lacquered, allow partial or total backing of the compositions, decorating the wall and hiding cables and wires.

Les panneaux de fond en MDF, disponibles en bois et laqués, permettent de recouvrir partiellement ou totalement la composition, en enrichissant le meuble et en dissimulant les câbles électriques.

Die Rückenplatten aus MDF sind aus Holznachbildung und lackiert verfügbar und ermöglichen die komplette oder teilweise Verkleidung der Komposition und bereichern so die Wand und verstecken eventuelle Stromkabel.

Los paneles traseros de MDF, disponibles en madera y lacados, permiten cubrir parcial o totalmente la composición, enriqueciendo la pared y ocultando los cables eléctricos.



4

I contenitori, disponibili in essenza e laccato, sono configurabili con frontali in HPL o vetro temprato, di soli 4mm di spessore. La semplificazione delle geometrie rende il volume compatto e raffinato.

The containers, available in wood and lacquered, can have HPL or tempered glass fronts with a thickness of just 4 mm. The simplicity of the geometries makes the unit compact and elegant.

Les conteneurs, disponibles en bois et laqués, peuvent être configurés avec des façades en HPL ou en verre trempé de seulement 4 mm d'épaisseur. La simplification des géométries rend le volume compact et épuré.

Die Behälter sind aus Holznachbildung oder lackiert verfügbar und sind mit der Stirnseite aus HPL oder Hartglas mit einer Stärke von nur 4 mm konfigurierbar. Die Vereinfachung der Formen machen das Volumen kompakt und raffiniert.

Los contenedores, disponibles en madera y lacados, pueden configurarse con frentes de HPL o de vidrio templado, de sólo 4 mm de grosor. La simplificación de las geometrías hace que el volumen sea compacto y refinado.

## FINITURE/FINISHES

⚠ verificare a listino dimensioni e finiture  
check dimensions and finishes in the price list

### profilo ews / ews profile

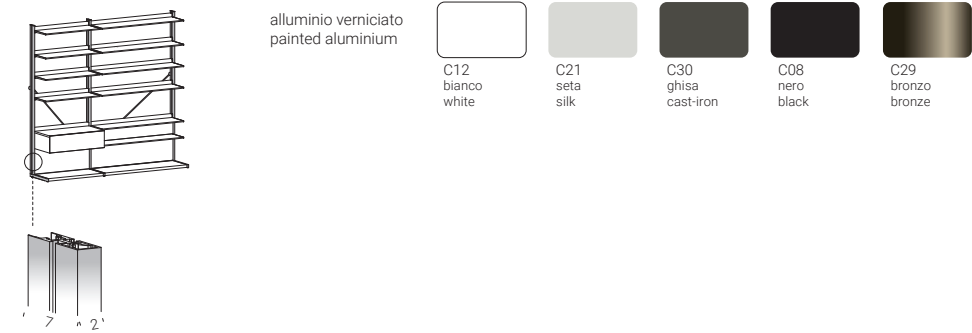

## DIMENSIONI/DIMENSIONS

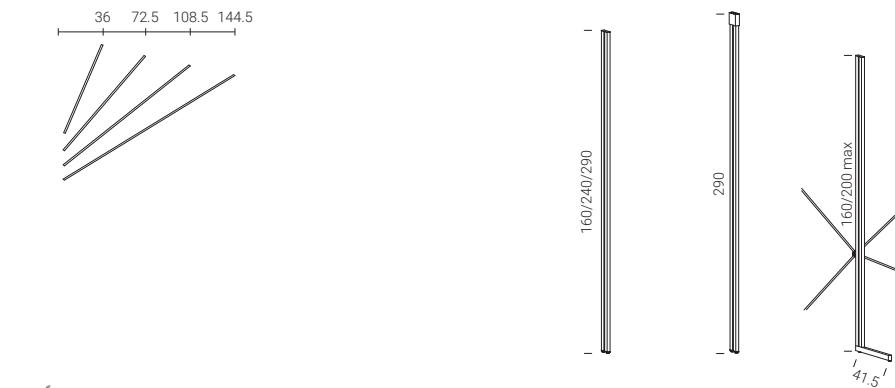

✂ cm disponibili riduzioni a misura / tailor-made reduction available

### ripiani e accessori / shelves and accessories

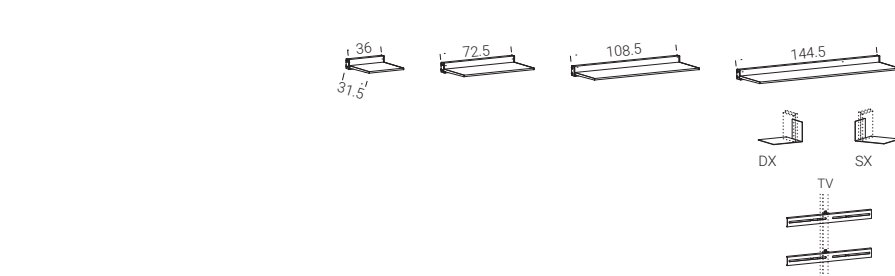

✂ cm disponibili riduzioni a misura / tailor-made reduction available

### contenitori / cabinets

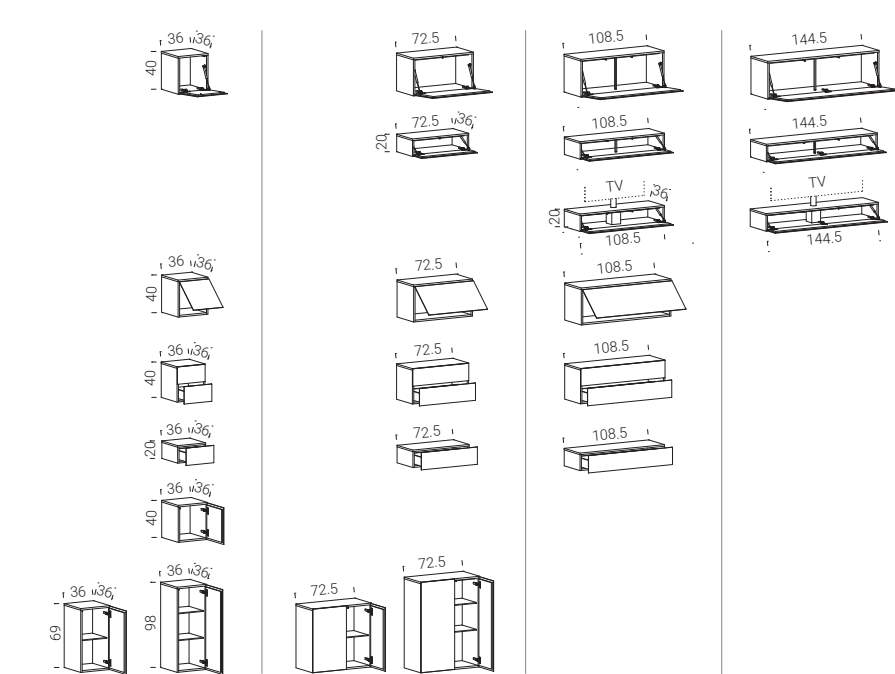

## FINITURE/FINISHES

⚠ verificare a listino dimensioni e finiture  
check dimensions and finishes in the price list

### pannello boiserie / boiserie panel



## DIMENSIONI/DIMENSIONS

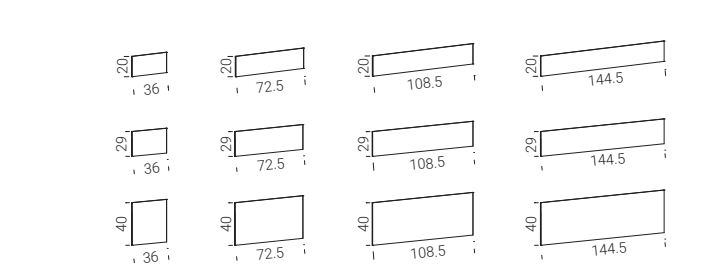

### top scrivania e boiserie / desktop and boiserie

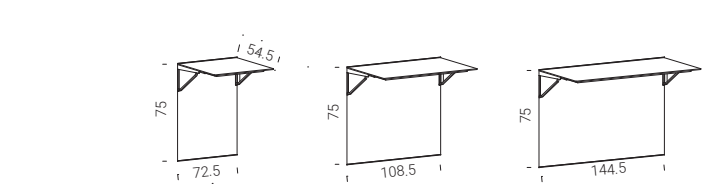
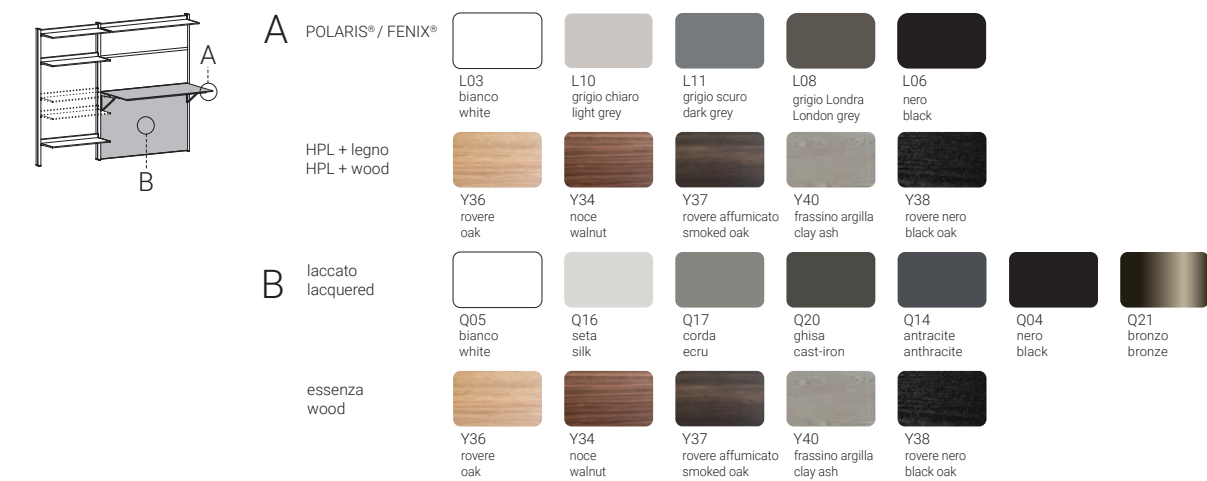

### ripiani a parete / wall shelves

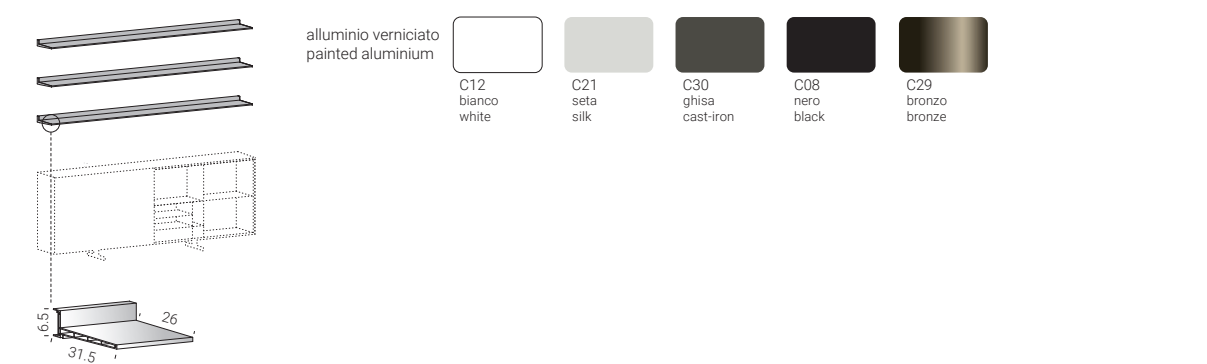



05/EWS

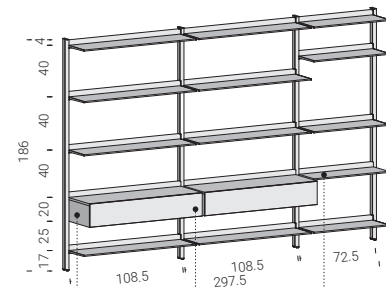

Q20 cast-iron  
Y34 walnut  
C30 cast-iron



ECH4 pg. 308



T11 pg. 250

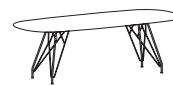



04/EWS

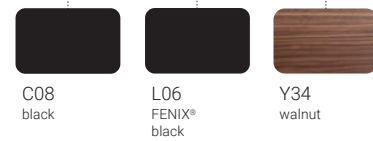
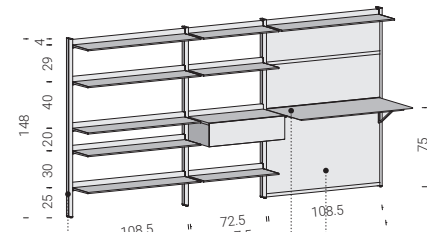

EWS

- Dettaglio anta
- Detail of a door
- Détail de la porte
- Türdetail
- Detalle de la puerta



ECH7

pg. 324





02/EWS

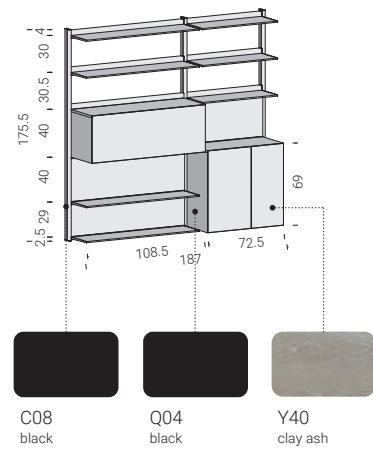

T7 pg. 218



CONTRAPPESO pg. 340

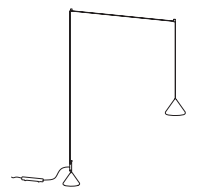



03/EWS

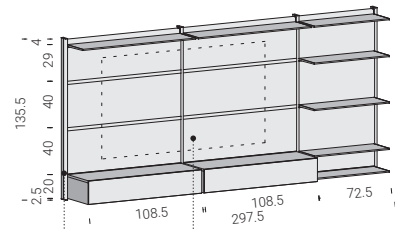

C29  
bronze



Y37  
smoked oak



EWS

- ▶ Pannello boiserie
- ▶ Boiserie panel
- ▶ Panneau en boiserie
- ▶ Tafelungsplatte
- ▶ Panel boiserie









06/EWS

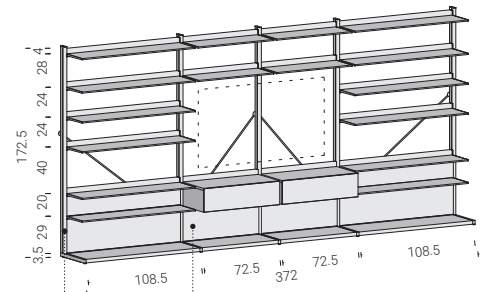

C30  
cast-iron



Y37  
smoked oak









01/EWS

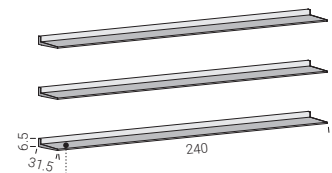

C30  
cast-iron

ECH4 pg. 308



MONOLITH pg. 74

