

# Frame

## Kitchens & workbenches

Salvatore Indriolo, 2018



**archiproducts**  
DESIGN AWARDS



[> go to the outdoor version](#)

Bases / Basi / Basen

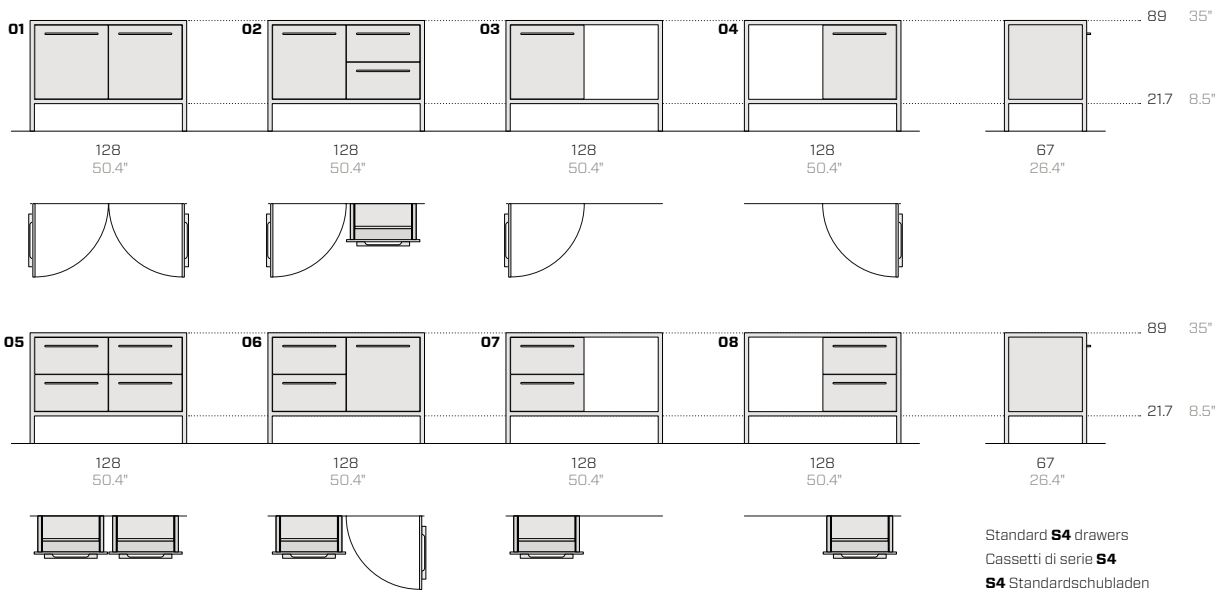

Tops (illustrated with a sink on the left) / Top (illustrati con vasca a sinistra) / Arbeitsplatten (abgebildet mit Becken auf der linken Seite)

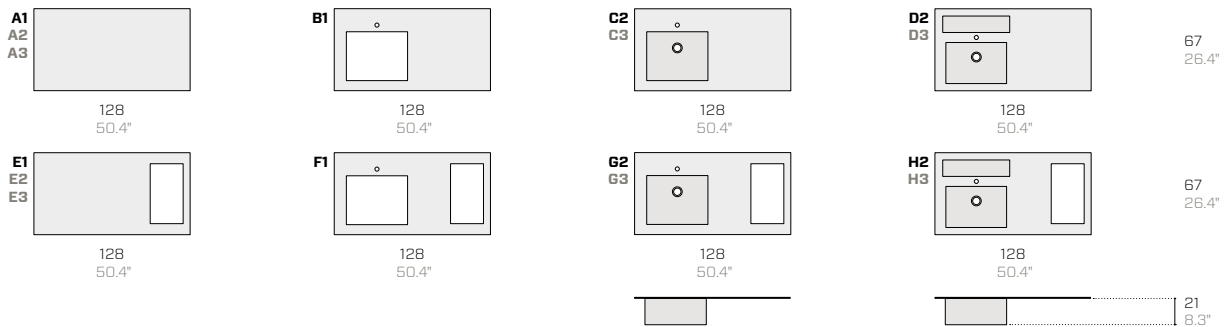

D, H with stainless steel equipment channel / D, H con canale attrezzato in inox / D, H mit vorgerüstetem Abfluss aus Edelstahl

Useful measurements of the stainless steel top / Quote utili del top in inox / Nützliche Maßen der Edelstahlplatte

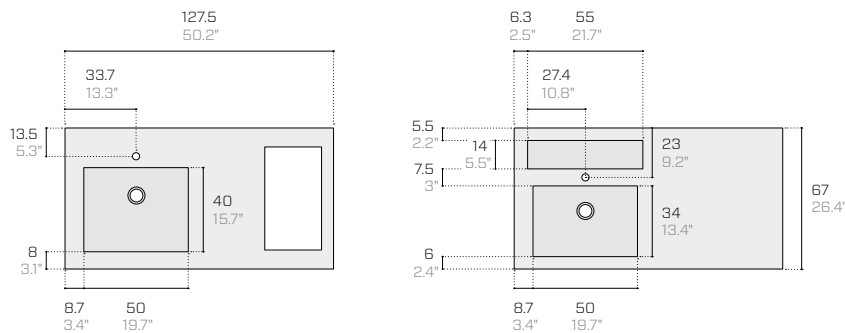

Product / Prodotto / Produkt					Packaging / Imballo / Verpackung					
No.	Code	Dimensions (w-d-h)			Weight	Dimensions (w-d-h)			Weight	Vol pkg
Nr.	Codice	Dimensioni (l-p-h)			Peso	Dimensioni (l-p-h)			Peso	Vol. collo
Nr.	Code	Abmessungen (b-t-h)			Gewicht	Abmessungen (b-t-h)			Gewicht	Vol. Kollo
			cm		kg		cm		kg	mc

## Bases / Basi / Basen

<b>01</b>	FR85	128	67	89	60	150	80	107	92	1.30
<b>02</b>	FR91D	128	67	89	70	150	80	107	102	1.30
<b>03</b>	FR84S	128	67	89	55	150	80	107	87	1.30
<b>04</b>	FR84D	128	67	89	55	150	80	107	87	1.30
<b>05</b>	FR93	128	67	89	60	150	80	107	112	1.30
<b>06</b>	FR91S	128	67	89	70	150	80	107	102	1.30
<b>07</b>	FR92S	128	67	89	65	150	80	107	97	1.30
<b>08</b>	FR92D	128	67	89	65	150	80	107	97	1.30

## Glass top / Top in vetro / Arbeitsplatte aus Glas

<b>A1</b>	FRV01A	128	67	0.6	12.5	143	82	12	20	0.20
<b>B1</b>	FRV02A	128	67	0.6	12.0	143	82	12	19	0.20
<b>E1</b>	FRV03A	128	67	0.6	12.0	143	82	12	19	0.20
<b>F1</b>	FRV04A	128	67	0.6	12.5	143	82	12	20	0.20

## Satin finish stainless steel top / Top in acciaio Inox satinato / Arbeitsplatte aus Edelstahl mit Satin-Finish

<b>A2</b>	FRX201S	128	67	0.4	27	137	80	21	37	0.30
<b>C2</b>	FRX203S	128	67	0.4	25	137	80	50	35	0.60
<b>D2</b>	FRX221S	128	67	0.4	27	137	80	50	37	0.60
<b>E2</b>	FRX202S	128	67	0.4	23	137	80	21	33	0.30
<b>G2</b>	FRX204S	128	67	0.4	22	137	80	50	32	0.60
<b>H2</b>	FRX222S	128	67	0.4	25	137	80	50	35	0.60

## Vintage finish stainless steel top (Barazza) / Top in acciaio Inox Vintage (Barazza) / Arbeitsplatte aus Edelstahl mit Vintage-Finish (Barazza)

<b>A3</b>	FRB41V	128	67	0.4	27	137	80	21	37	0.30
<b>C3</b>	FRB45V	128	67	0.4	25	137	80	50	35	0.60
<b>D3</b>	FRB94V	128	67	0.4	27	137	80	50	37	0.60
<b>E3</b>	FRB43V	128	67	0.4	23	137	80	21	33	0.30
<b>G3</b>	FRB46V	128	67	0.4	22	137	80	50	32	0.60
<b>H3</b>	FRB95V	128	67	0.4	25	137	80	50	35	0.60

## Upstand (stainless steel, satin and Vintage finish) / Alzatina (acciaio inox, satinato o Vintage) / Wischleiste (Edelstahl, satin- und Vintage-Finish)

-	FRX217S	128	0.4	4	2.5	137	2	10	3	0.10
-	FRB81V	128	0.4	4	2.5	137	2	10	3	0.10

- Scan the QR code to the side to find out more about fitting the hobs in holes in the tops. Fantin shall accept no liability for the assembly and installation of other appliances. If you wish to install other appliances, download the document that is available here and consult it with a qualified fitter.
- Dal QR-Code qui a fianco è possibile approfondire le forature dei top per l'installazione dei piani cottura. Fantin non si assume responsabilità per montaggio e installazione di altri elettrodomestici. In tal caso, si consiglia di consultare il documento qui scaricabile con un installatore qualificato.
- Über den QR-Code auf der rechten Seite können Sie mehr über die Bohrungen für den Einbau Kochfelder erfahren. Fantin übernimmt keine Haftung für die Montage und Installation anderer Küchengeräte. In diesem Fall empfehlen wir, die Beschreibung, die hier heruntergeladen werden kann, mit einem qualifizierten Installateur zu konsultieren.



Bases / Basi / Basen

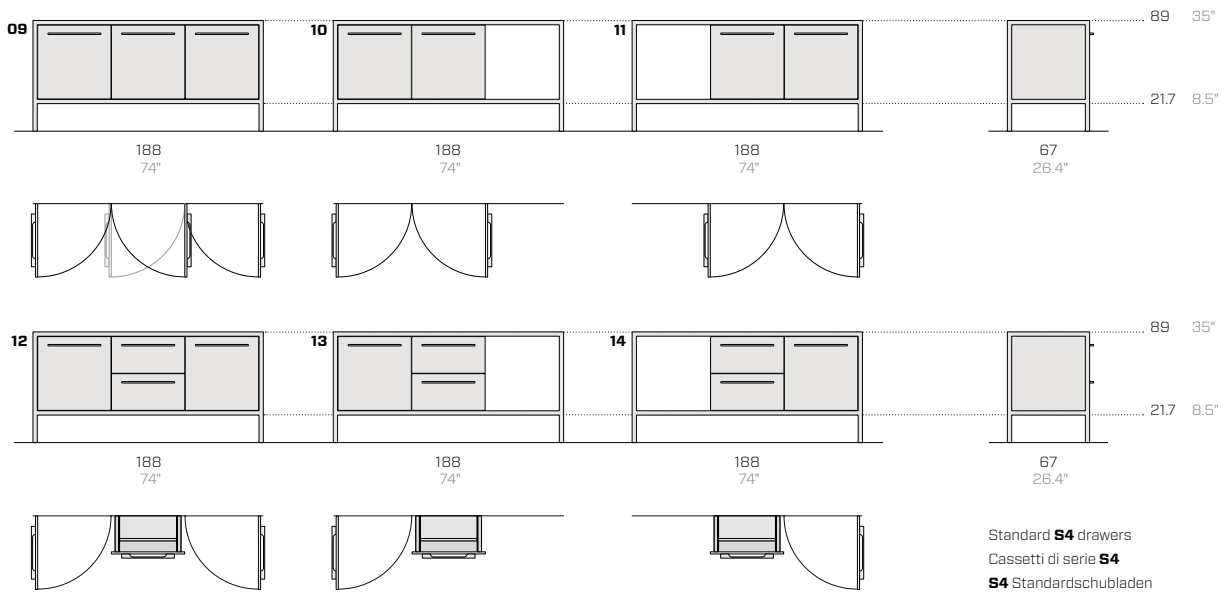

Tops (illustrated with a sink on the left) / Top (illustrati con vasca a sinistra) / Arbeitsplatten (abgebildet mit Becken auf der linken Seite)

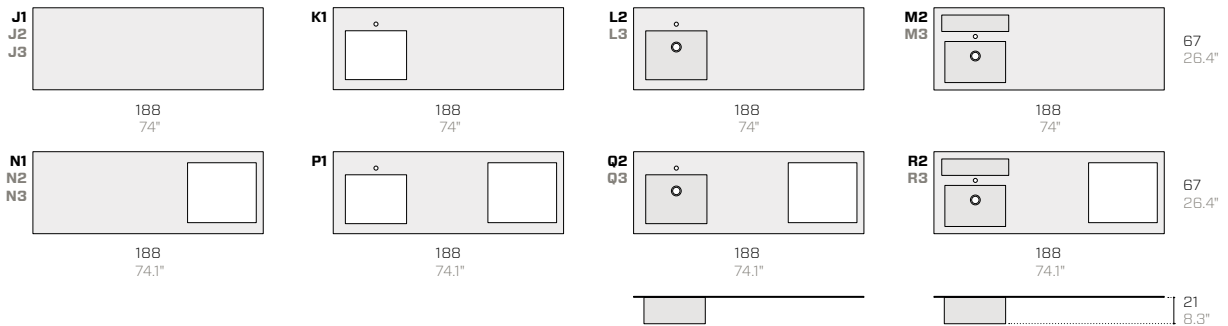

M, R with stainless steel equipment channel / M, R con canale attrezzato in inox / M, R mit vorgerüstetem Abfluss aus Edelstahl

Useful measurements of the stainless steel top / Quote utili del top in inox / Nützliche Maßen der Edelstahlplatte

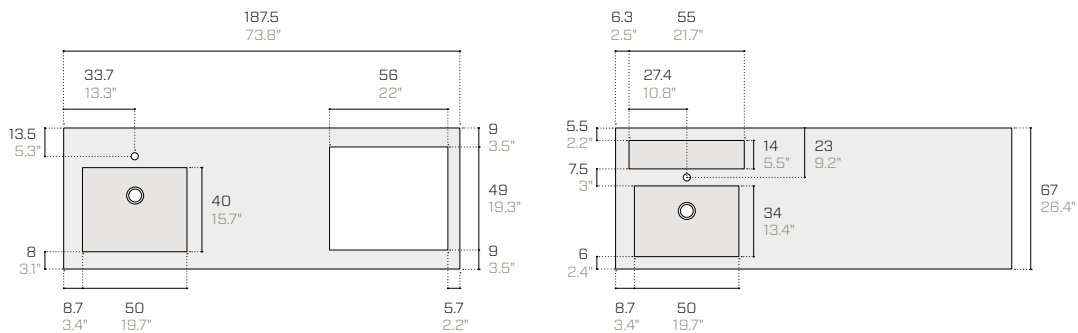

**Product / Prodotto / Produkt**

**Packaging / Imballo / Verpackung**

No.	Code	Dimensions (w-d-h)	Weight	Dimensions (w-d-h)	Weight	Vol pkg
Nr.	Codice	Dimensioni (l-p-h)	Peso	Dimensioni (l-p-h)	Peso	Vol. collo
Nr.	Code	Abmessungen (b-t-h)	Gewicht	Abmessungen (b-t-h)	Gewicht	Vol. Kollo
		cm	kg	cm	kg	mc

**Bases / Basi / Basen**

<b>09</b>	FR87	188 67 89	92	200 80 107	135	1.80
<b>10</b>	FR86S	188 67 89	87	200 80 107	130	1.80
<b>11</b>	FR86D	188 67 89	87	200 80 107	130	1.80
<b>12</b>	FR83	188 67 89	102	200 80 107	145	1.80
<b>13</b>	FR82S	188 67 89	97	200 80 107	140	1.80
<b>14</b>	FR82D	188 67 89	97	200 80 107	140	1.80

Glass top / Top in vetro / Arbeitsplatte aus Glas

<b>J1</b>	FRV05A	188 67 0.6	18.5	203 82 12	29	0.20
<b>K1</b>	FRV06A	188 67 0.6	18.0	203 82 12	28	0.20
<b>N1</b>	FRV07A	188 67 0.6	18.0	203 82 12	28	0.20
<b>P1</b>	FRV08A	188 67 0.6	18.5	203 82 12	29	0.20

Satin finish stainless steel top / Top in acciaio Inox satinato / Arbeitsplatte aus Edelstahl mit Satin-Finish

<b>J2</b>	FRX209S	188 67 0.4	40	197 80 21	50	0.40
<b>L2</b>	FRX211S	188 67 0.4	38	197 80 50	48	0.80
<b>M2</b>	FRX225S	188 67 0.4	39	197 80 50	49	0.80
<b>N2</b>	FRX210S	188 67 0.4	31	197 80 21	41	0.40
<b>Q2</b>	FRX212S	188 67 0.4	30	197 80 50	40	0.80
<b>R2</b>	FRX226S	188 67 0.4	35	197 80 50	45	0.80

Vintage finish stainless steel top (Barazza) / Top in acciaio Inox Vintage (Barazza) / Arbeitsplatte aus Edelstahl mit Vintage-Finish (Barazza)

<b>J3</b>	FRB71V	188 67 0.4	40	197 80 21	50	0.40
<b>L3</b>	FRB75V	188 67 0.4	38	197 80 50	48	0.80
<b>M3</b>	FRB98V	188 67 0.4	39	197 80 50	49	0.80
<b>N3</b>	FRB73V	188 67 0.4	31	197 80 21	41	0.40
<b>Q3</b>	FRB76V	188 67 0.4	30	197 80 50	40	0.80
<b>R3</b>	FRB99V	188 67 0.4	35	197 80 50	45	0.80

Upstand (stainless steel, satin and Vintage finish) / Alzatina (acciaio inox, satinato o Vintage) / Wischleiste (Edelstahl, satin- und Vintage-Finish)

-	FRX219S	188 0.4 4	3.5	197 2 10	4	0.10
-	FRB82V	188 0.4 4	3.5	197 2 10	4	0.10

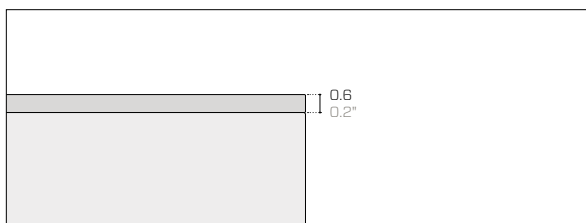

Glass top / Top in vetro / Arbeitsplatte aus Glas

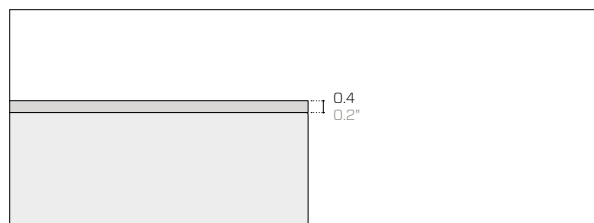

Stainless steel top / Top in acciaio inox / Arbeitsplatte aus Edelstahl

**Stainless steel accessories for tops / Accessori in inox per top / Zubehör aus Edelstahl für die Arbeitsplatten**

**S1**

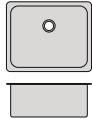

Satin overtop sink  
Vasca satinata sopratop  
Satiniertes Überbaubecken

BARAZZA

**S2**



Roll-up draining mat  
Griglia multiuso avvolgibile  
Aufrollbare Abtropfmatte

**S3**  
**S4**

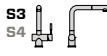

Steel taps  
Rubinetti  
Wasserhähne

BARAZZA

**S5**  
**S6**

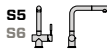

S4: Chrome / Cromato / Chrom  
S5: Black / Nero / Schwarz  
S6: Barazza Inox Satin  
S7: Barazza Inox Vintage

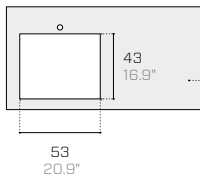

Hole size for the S1 sink  
Foratura top per vasca S1  
Größe der Bohrungen für Beck S1

For tops with a thickness over 14 mm, check the slot for the overflow.  
Per top con spessore superiore a 14 mm, verificare lo scanco per il troppopieno.  
Für Arbeitsplatten mit einer Stärke von mehr als 14 mm, die Übereinstimmung mit dem Überlauf ist zu überprüfen.

**SST accessories for the equipment channel / Accessori in inox per canale attrezzato / Zubehör aus Edelstahl für vorgerüsteten Abfluss**

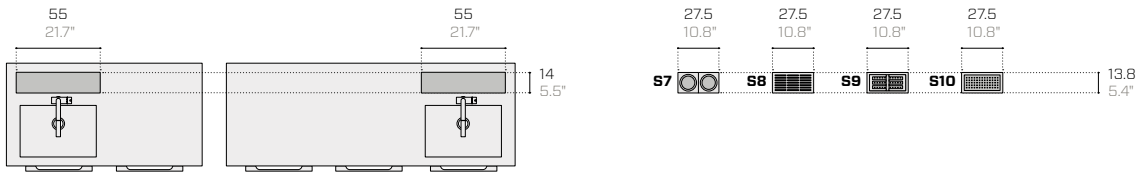

The equipment channel (H 20 cm) can hold a choice of 2 different items. Satin-finish AISI 304 stainless steel channel and accessories.  
Il canale attrezzato (H 20 cm) contiene 2 accessori combinabili a scelta. Canale e accessori in acciaio inox AISI 304 satinato.  
Der vorgerüstete Abfluss (H 20 cm) umfasst 2 Zubehörteile, die wahlweise kombiniert werden können. Abfluss und Zubehör aus satiniertem Edelstahl AISI 304.



**S7**  
Bottle rack (H 17 cm; 2 pieces)  
Portabottiglie (H 17 cm; 2 elementi)  
Flaschenhalter (H 17 cm; 2 Elemente)



**S8**  
Glass drainer (H 1.5 cm)  
Scolabicchieri (H 1.5 cm)  
Abtropfgitter (H 1.5 cm)



**S9**  
Dish drainer (H 7 cm)  
Scolapiatti (H 7 cm)  
Abtropfgestell (H 7 cm)



**S10**  
Sink (H 7 cm)  
Vaschetta (H 7 cm)  
Wanne (H 7 cm)

Product / Prodotto / Produkt					Packaging / Imballo / Verpackung					
No.	Code	Dimensions (w-d-h)		Weight	Dimensions (w-d-h)		Weight	Vol pkg		
Nr.	Codice	Dimensioni (l-p-h)		Peso	Dimensioni (l-p-h)		Peso	Vol. collo		
Nr.	Code	Abmessungen (b-t-h)		Gewicht	Abmessungen (b-t-h)		Gewicht	Vol. Kollo		
		cm		kg	cm		kg	mc		
Overtop sink in inox satin / Vasca sopratop in inox satinato / Überbaubecken in Inox Satin										
S1	FRX01S	54	44	20	4	60	50	26	7	0.10
Roll-up draining mat / Griglia multiuso avvolgibile / Aufrollbare Abtropfmatte										
S2	FRB11	47	45	1	1	50	8	8	1	0.10
Steel taps / Rubinetti / Wasserhähne										
S3	FRB10C	13	26	27	5	59	25	10	8	0.10
S4	FRB10N	13	26	27	5	59	25	10	8	0.10
S5	FRB10S	13	26	27	5	59	25	10	8	0.10
S6	FRB10V	13	26	27	5	59	25	10	8	0.10
SST accessories for the equipment channel / Accessori in inox per canale attrezzato / Zubehör aus Edelstahl für vorgerüsteten Abfluss										
S7	FRB13S	27.5	13.8	17.0	1.0	30	23	24.0	1.2	0.10
S8	FRB14S	27.5	13.8	1.5	0.5	34	18	3.5	0.6	0.10
S9	FRB15S	27.5	13.8	7.0	1.3	30	23	12.0	1.4	0.10
S10	FRB16S	27.5	13.8	7.0	1.5	30	23	12.0	1.6	0.10
Back panel for freestanding kitchen / Schiena per cucina freestanding / Rückwand für freistehende Küche										
-	FRK01S1	120	3	60	6	124	64	7	7	0.10
-	FRK02S2	180	3	60	9	184	64	7	10	0.10
Floor attachment cover kit / Kit di copertura allacciamenti a pavimento / Set für Abdeckung der Anschlüsse am Boden										
-	FRK03A1	60	20	25	3	62	22	27	5	0.10



Drawer kits / Kit cassetti / Schubladen-Set

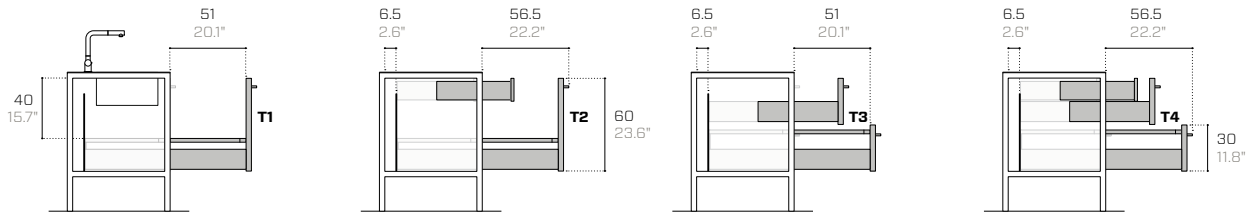

**T1**  
Kit 1 large drawer  
Kit 1 cassettone  
Set 1 Kommode

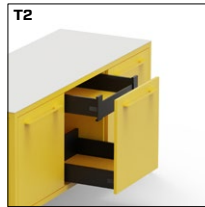

**T2**  
Kit 1 large drawer + 1 inner drawer  
Kit 1 cassettone + cassetto interno  
Set 1 Kommode + 1 Innenfach

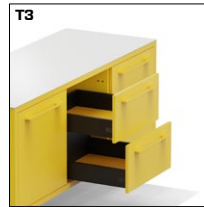

**T3**  
Kit 2 drawers  
Kit 2 cassetti  
Set 2 Schubladen

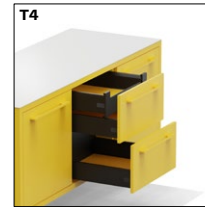

**T4**  
Kit 2 drawers + 1 inner drawer  
Kit 2 cassetti + cassetto interno  
Set 2 Schubladen + 1 Innenfach

Wheel kit with colour-matching discs / Kit ruote con dischi in tinta / Radsatz mit farblich abgestimmten Scheiben

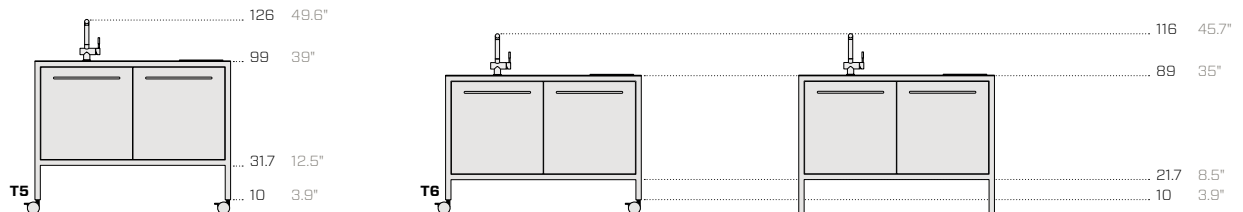

Kitchen height (with wheels)  
Altezza cucina (con ruote)  
Küchenhöhe (mit Rädern)

Kitchen with wheel kit and resized legs (same overall height as the kitchen without wheel kit)  
Cucina con kit ruote e gambe ridimensionate (stessa altezza complessiva della cucina senza kit ruote)  
Küche mit Radsatz und verkleinerte Beine (gleiche Gesamthöhe wie der Küche ohne Radsatz)



**T5**



Product / Prodotto / Produkt

Packaging / Imballo / Verpackung

No.	Code	Dimensions (w-d-h)	Weight	Dimensions (w-d-h)	Weight	Vol pkg
Nr.	Codice	Dimensioni (l-p-h)	Peso	Dimensioni (l-p-h)	Peso	Vol. collo
Nr.	Code	Abmessungen (b-t-h)	Gewicht	Abmessungen (b-t-h)	Gewicht	Vol. Kollo
		cm	kg	cm	kg	mc

Drawer kits (surcharge on the door price) / Kit cassetti (sovrapprezzo costo anta) / Schubladen-Set (Zuschlag auf den Türpreis)

T1	FRK21C1	60 55 60	13	63 58 63	14	0.30
T2	FRK20C2	60 55 60	18	63 58 63	19	0.30
T3	FRK22C2	60 55 60	15	63 58 63	16	0.30
T4	FRK23C3	60 55 60	20	63 58 63	21	0.30

Aluminum cutlery dividers / Divisori portaposate in alluminio / Besteckteiler aus aluminium

-	FRK14DP	48 8 5	1	50 10 6	1	0.10
---	---------	--------	---	---------	---	------

Waste separation systems / Kit di contenitori per raccolta differenziata / Abfalltrennsystem

-	FRK61DIF	44 29 22	3	50 10 6	4	0.10
-	FRK60DIF	46 30 30	2	50 10 6	3	0.10

Additional shelf / Ripiano aggiuntivo / Zusätzlicher Einlegeboden

-	FRK10R1	57 46 2	3	50 10 6	3	0.10
---	---------	---------	---	---------	---	------

Wheel kit with colour-matching discs / Kit ruote con dischi in tinta / Radsatz mit farblich abgestimmten Scheiben

T5	FRK31R8	8 3.5 10	2	20 10 10	3	0.10
T6	FRK33R8	8 3.5 10	2	20 10 10	3	0.10

Other useful measurements / Altre quote utili / Andere nützliche Maßen

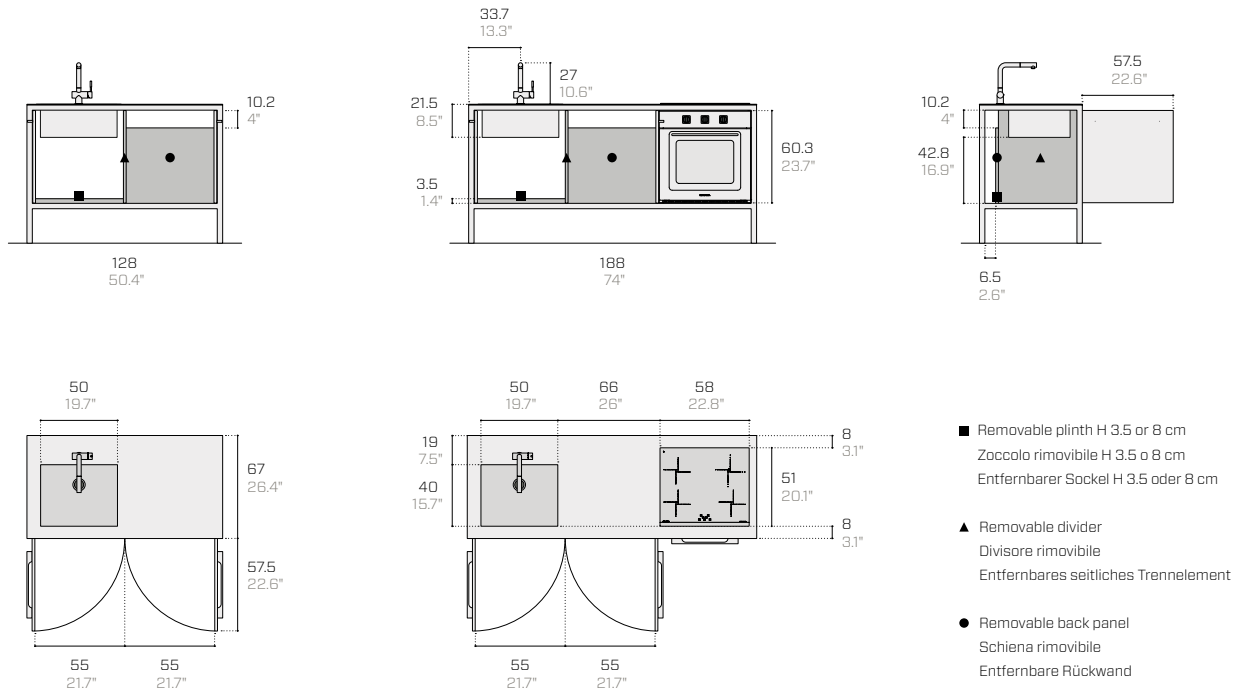

**Shelf / Mensola / Regalbrett**

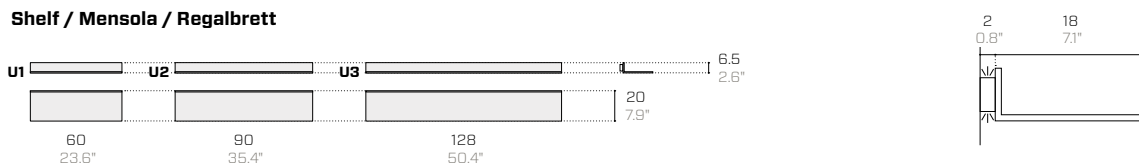

U3 compatible with 3000K LED bar / U3 compatibile con barra LED 3000K / U3 kompatibel mit 3000K LED Bar

**Open compartment / Vano a giorno / Offenes Fach**

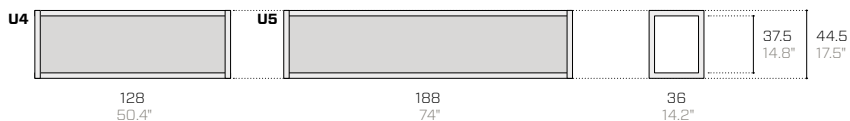
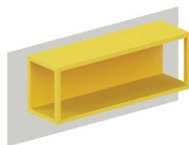

**Wall panelling / Boiserie a parete / Wandverkleidungen**

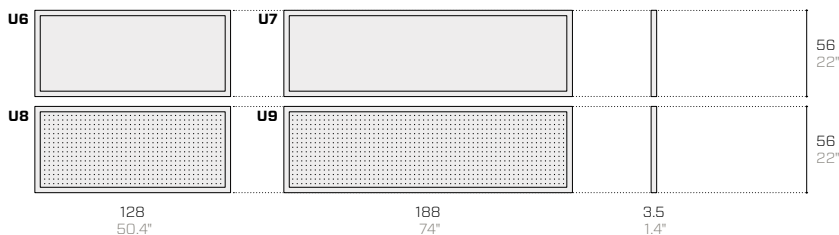

**Wall panelling with shelf / Boiserie a parete con mensola / Wandverkleidungen mit Regal**

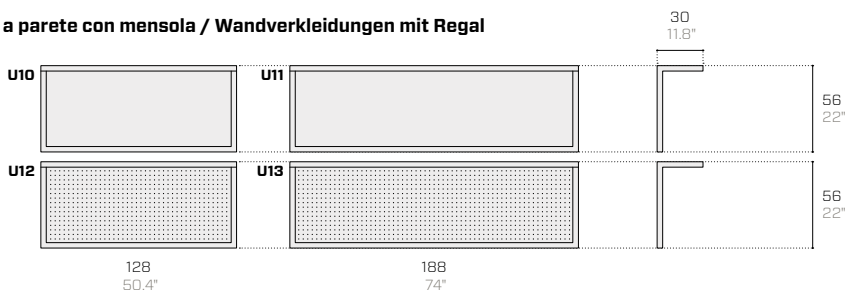

Items compatible with 3000K LED bar / Modelli compatibili con barra LED 3000K / Modelle kompatibel mit 3000K LED Bar

**Useful measurements / Quote utili / Nützliche Maßen**

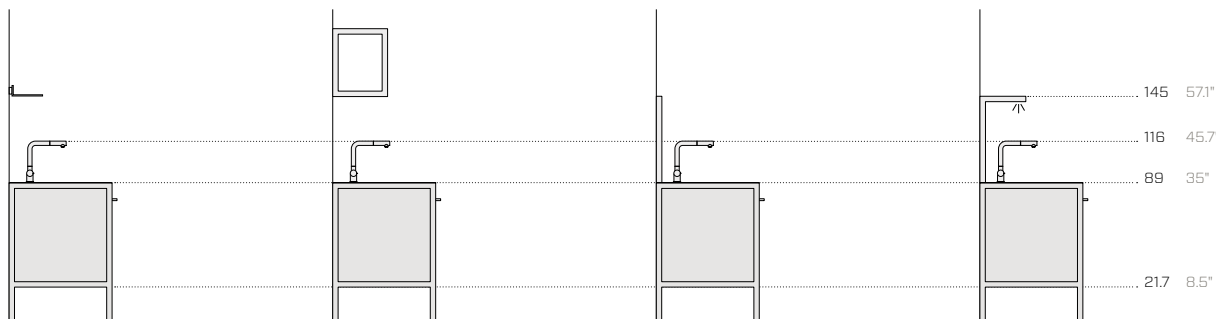

**U1 / U2 / U3**  
Free scope for wall mounting  
Fissaggio libero a parete  
Freie Wandmontage

**U4 / U5**  
Free scope for wall mounting  
Fissaggio libero a parete  
Freie Wandmontage

**U6 / U7 / U8 / U9**  
Free scope for wall mounting  
Fissaggio libero a parete  
Freie Wandmontage

**U10 / U11 / U12 / U13 \***  
Attachment to kitchen and wall  
Fissaggio alla cucina e alla parete  
Montage an Herd und Wand

\* U10 / U11 / U12 / U13 - For glass tops, attachment to the wall only / Per top in vetro, fissaggio solo alla parete / Für die Arbeitsplatte aus Glas nur Wandmontage

Product / Prodotto / Produkt					Packaging / Imballo / Verpackung					
No.	Code	Dimensions (w-d-h)			Weight	Dimensions (w-d-h)			Weight	Vol pkg
Nr.	Codice	Dimensioni (l-p-h)			Peso	Dimensioni (l-p-h)			Peso	Vol. collo
Nr.	Code	Abmessungen (b-t-h)			Gewicht	Abmessungen (b-t-h)			Gewicht	Vol. Kollo
				cm	kg			cm	kg	mc
Shelf / Mensola / Regalbrett										
U1	FRM13	60	20	6.5	4.0	70	30	20	5.0	0.10
U2	FRM14	90	20	6.5	6.0	100	30	20	7.0	0.10
U3	FRM15	128	20	6.5	8.5	140	30	20	9.5	0.10
Open compartment / Vano a giorno / Offenes Fach										
U4	FRM11	128	36	44.5	30	140	40	10	32	0.10
U5	FRM12	188	36	44.5	45	200	40	10	47	0.10
Solid sheet metal wall panelling / Boiserie a parete in lamiera piena / Wandverkleidungen aus Vollblech										
U6	FRM07	128	3.5	56	14	140	60	10	17	0.10
U7	FRM08	188	3.5	56	20	200	60	10	23	0.20
Perforated sheet metal wall panelling / Boiserie a parete in lamiera forata / Wandverkleidungen aus Lochblech										
U8	FRM09	128	3.5	56	13	140	60	10	16	0.10
U9	FRM10	188	3.5	56	19	200	60	10	22	0.20
Solid sheet metal wall panelling with shelf / Boiserie a parete in lamiera piena con mensola / Wandverkleidungen aus Vollblech mit Regal										
U10	FRM01	128	30	56	18	140	60	40	21	0.40
U11	FRM02	188	30	56	27	200	60	40	31	0.50
Perforated sheet metal wall panelling with shelf / Boiserie a parete in lamiera forata con mensola / Wandverkleidungen aus Lochblech mit Regal										
U12	FRM05	128	30	56	17	140	60	40	20	0.40
U13	FRM06	188	30	56	26	200	60	20	30	0.30
LED bar 3000K (10W per meter) / Barra LED 3000K (10W per metro) / LED-Lichtleiste 3000K (10W pro Meter)										
-	FRS128L3	121	3.5	3.5	0.2	124	6.5	6.5	0.2	0.10
-	FRS188L3	181	3.5	3.5	0.3	184	6.5	6.5	0.3	0.10
24V-30W Power supply kit / Kit con alimentatore 24V-30W / Netzteil 24V-30W										
-	FRSK1LPS	-	-	-	0.2	-	-	-	0.2	-
Magnetic dimmer switch / Interruttore dimmer magnetico / Magnetischer Dimmer										
-	FRSK6D	-	-	-	-	-	-	-	-	-
Kit of 5 hooks / Kit di 5 gancetti / Kit mit 5 Haken										
-	FRK29GA	-	-	-	0.1	-	-	-	0.1	-
Kit of 5 magnets / Kit di 5 calamite / Kit mit 5 Magneten										
-	FRK28CA	-	-	-	0.1	-	-	-	0.1	-

Hobs / Piani cottura / Kochfelder

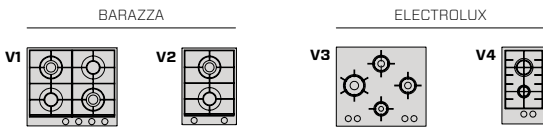

Gas hobs  
Piani cottura a gas  
Gaskochfelder

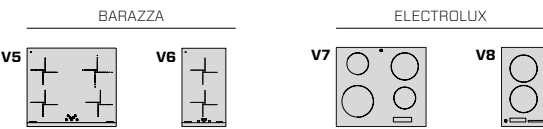

Electric induction hobs  
Piani cottura elettrici a induzione  
Elektrische Induktionskochfelder

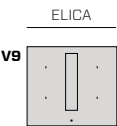

Electric induction hob with integrated filtering hood  
Piano cottura elettrico a induzione con cappa integrata filtrante  
Elektrisches Induktionskochfeld mit integrierter Filterhaube

Shelf with integrated Falmecc hood / Mensola con cappa Falmecc integrata / Regalbrett mit integrierter Filterhaube Falmecc

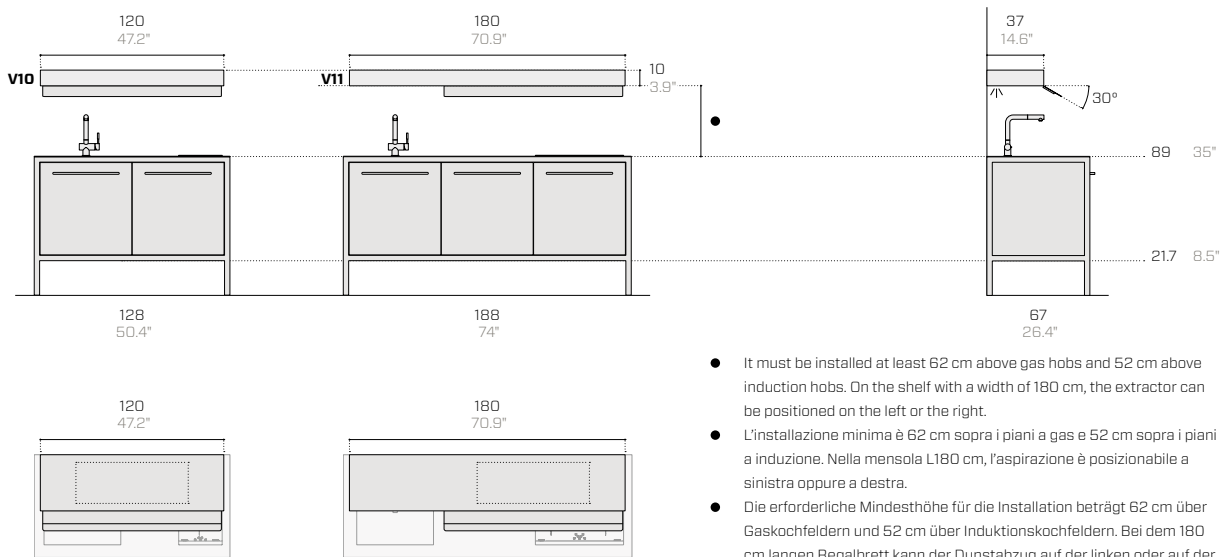

- It must be installed at least 62 cm above gas hobs and 52 cm above induction hobs. On the shelf with a width of 180 cm, the extractor can be positioned on the left or the right.
- L'installazione minima è 62 cm sopra i piani a gas e 52 cm sopra i piani a induzione. Nella mensola L180 cm, l'aspirazione è posizionabile a sinistra oppure a destra.
- Die erforderliche Mindesthöhe für die Installation beträgt 62 cm über Gaskochfeldern und 52 cm über Induktionskochfeldern. Bei dem 180 cm langen Regalbrett kann der Dunstabzug auf der linken oder auf der rechten Seite positioniert werden.

**Product / Prodotto / Produkt**

**Packaging / Imballo / Verpackung**

No.	Code	Brand code	Dimensions (w-d-h)			Weight	Dimensions (w-d-h)			Weight
N.	Codice	Codice marca	Dimensioni (l-p-h)			Peso	Dimensioni (l-p-h)			Peso
Nr.	Code	Herstellercode	Abmessungen (b-t-h)			Gewicht	Abmessungen (b-t-h)			Gewicht
			cm			kg	cm			kg

Gas hobs / Piani cottura a gas / Gaskochfelder

V1	FRE32	1PBF64	58.5	51	5.2	12	87	60	13	14
V2	FRE31	1PBF2	36.0	51	5.4	6	39	60	13	10
V3	FRE33	PQF645UOX	59.5	52	6.5	12	80	60	15	14
V4	FRE21	EGG3222N	29.0	49	6.5	6	48	60	15	10

Electric induction hobs / Piani cottura elettrici a induzione / Elektrische Induktionskochfelder

V5	FRB05-F4	1PIDC60N	58.0	51	5.2	12	87	60	13	14
V6	FRB06-F2	1PIDC30N	28.5	51	5.4	6	39	60	13	10
V7	FRE04	KTI6430E	59.0	52	6.5	12	80	60	15	14
V8	FRE02	LIT30231C	27.0	49	6.5	6	48	60	15	10

Aspirating induction hob (w/installation kit) / Piano induzione aspirante (con kit di installazione) / Induktionskochfeld mit Dunstabzug (mit Einbausatz)

V9	FRE37	PRF0167053	60	51.5	26	20	80	60	30	22
----	-------	------------	----	------	----	----	----	----	----	----

Kit for aspirating induction hob / Kit per piano induzione aspirante / Bausatz für Induktionskochfeld mit Dunstabzug

xV9	FRE37-KIT	-	-	-	-	-	-	-	-	-
-----	-----------	---	---	---	---	---	---	---	---	---

Shelf with integrated Falmecc hood / Mensola con cappa Falmecc integrata / Regalbrett mit integrierter Filterhaube Falmecc

V10	FR97	-	120.5	37	10.5	25	-	-	-	35
V11	FR98	-	180.5	37	10.5	35	-	-	-	45

Frame kitchens are compatible with Miele appliances

Le cucine Frame sono compatibili con l'installazione di elettrodomestici Miele

Frame Herde sind mit der Installation von Geräten der Marke Miele kompatibel

**Examples of compositions / Esempi di composizioni / Kompositionsbeispiele**

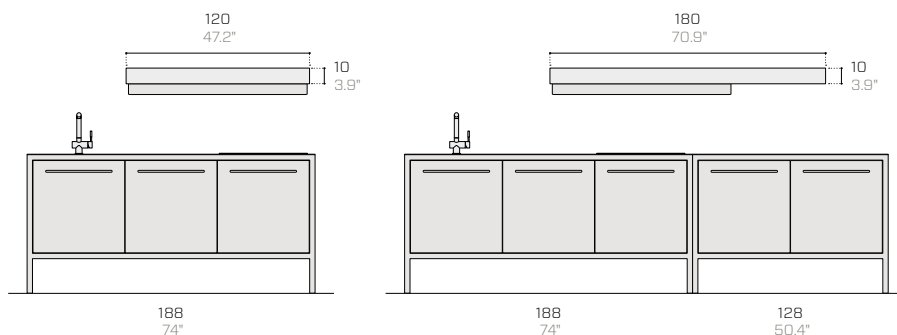

Custom widths (in multiples of 60 cm) are available on request.

Larghezze custom (con passo 60 cm) su richiesta.

Kundenspezifische Breiten (mit 60-cm-Raster) auf Anfrage.

**Integrated appliances / Elettrodomestici a incasso / Einbaugeräte**

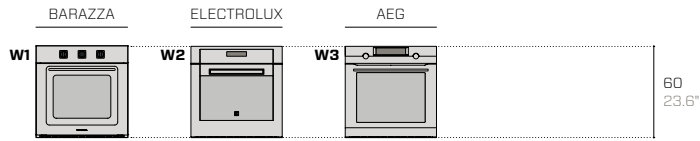

Ovens / Forni / Öfen

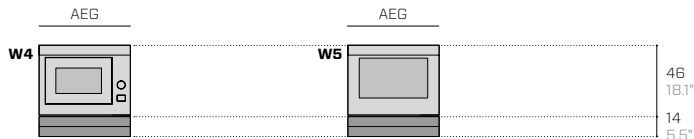

Microwave (+ drawer)  
Microonde (+ cassetino)  
Microwelle (+ Schublade)

Wine cooler (+ drawer)  
Cantinetta (+ cassetino)  
Weinkühlschrank (+ Schublade)

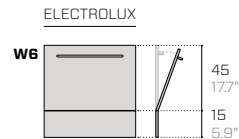

Dishwasher with Fantin door  
Lavastoviglie con anta Fantin  
Geschirrspüler mit Fantin Tür

**Freestanding appliance kits / Kit per elettrodomestici a terra / Bausatz für die Bodenmontage von Haushaltsgeräten**



Only door  
Solo anta  
Nur Tür

Kits for refrigerators  
Kit per frigoriferi  
Bausätze für Kühlschränke

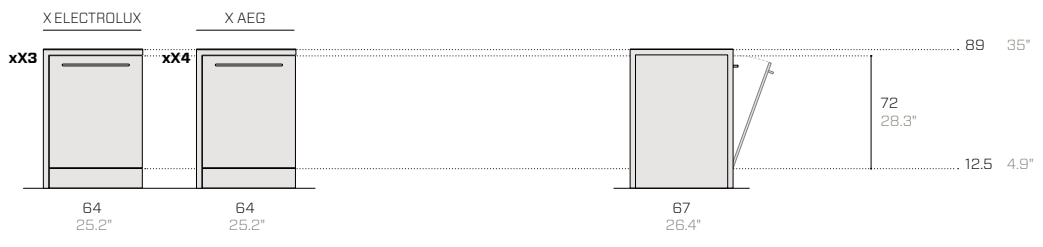

Kits for dishwashers  
Kit per lavastoviglie  
Bausätze für Geschirrspüler

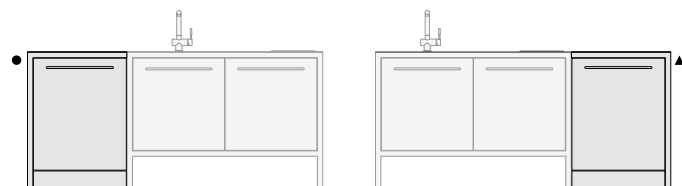

The kits can be placed on either the left [●] or the right [▲].

Il kit è posizionabile sia a sinistra [●] sia a destra [▲].

Der Bausatz kann sowohl links [●] als auch rechts [▲] positioniert werden.

Product / Prodotto / Produkt					Packaging / Imballo / Verpackung					
No.	Code	Brand code	Dimensions (w-d-h)			Weight	Dimensions (w-d-h)			Weight
Nr.	Codice	Codice marca	Dimensioni (l-p-h)			Peso	Dimensioni (l-p-h)			Peso
Nr.	Code	Herstellercode	Abmessungen (b-t-h)			Gewicht	Abmessungen (b-t-h)			Gewicht
			cm			kg	cm			kg

Integrated appliances (w/installation kit) / Elettrodomestici a incasso (con kit di installazione) / Einbaugeräte (mit Einbausatz)

<b>W1</b>	FRB02V-FV	1FUAM	60	61	60	35	64	64	68	39
<b>W2</b>	FRE03	KOFFP46TX	60	60	55	33	64	64	68	37
<b>W3</b>	FRE05	BEK435220M	60	60	55	33	64	64	68	37
<b>W4</b>	FRE11	MBE2658DEM	60	53	60	28	66	54	53	31
<b>W5</b>	FRE13	KWK884520M	60	53	60	28	66	54	53	31
<b>W6</b>	FRE36	ESL2500RO	56	55	45	38	60	56	51	40

Kits for integrated appliances / Kit per elettrodomestici a incasso / Bausätze für Einbaugeräte

<b>xW1</b>	FRB02V-KIT	-	2	7	58	2	10	10	84	3
<b>xW2</b>	FRE03-KIT	-	2	7	58	2	10	10	84	3
<b>xW3</b>	FRE05-KIT	-	2	7	58	2	10	10	84	3
<b>xW4</b>	FRE11-KIT	-	2	7	58	2	10	10	84	3
<b>xW5</b>	FRE13-KIT	-	2	7	58	2	10	10	84	3
<b>xW6</b>	FRE36-KIT	-	60	60	25	2	10	10	84	3

Freestanding additional door kit / Kit anta aggiuntiva a terra / Bausatz für zusätzliche Tür am Boden

<b>X</b>	FRK13ET	-	64	67	89	18	67	70	92	23
----------	---------	---	----	----	----	----	----	----	----	----

Freestanding appliances (no kit) / Elettrodomestici a terra (senza kit) / Bodengeräte (ohne Bausatz)

<b>[X1]</b>	FRE40	LSB2AF82S	56	55	82	31	63	63	87	33
<b>[X2]</b>	FRE41	SFB682E1AF	56	55	82	35	63	63	87	37
<b>[X3]</b>	FRE43	KESC8300L	60	55	82	37	63	63	87	38
<b>[X4]</b>	FRE44	FSK73737P	60	55	82	37	63	63	87	38

Freestanding appliance kits / Kit per elettrodomestici a terra / Bausatz für Bodengeräte

<b>xx1</b>	FRE40-KIT	-	64	67	89	18	67	70	92	23
<b>xx2</b>	FRE41-KIT	-	64	67	89	18	67	70	92	23
<b>xx3</b>	FRE43-KIT	-	64	67	89	18	67	70	92	23
<b>xx4</b>	FRE44-KIT	-	64	67	89	18	67	70	92	23

• Scan the QR code to find out more about the assembly and installation kits for the appliances in the table (included in the prices of the appliances themselves or available for purchase separately). Fantin shall accept no liability for the assembly and installation of other appliances. If you wish to install other appliances, download the document that is available here and consult it with a qualified fitter. Frame Kitchen are compatible with Miele appliances whose dimensions match the details given in the document that can be downloaded by scanning the QR code. For appliances of this kind, Fantin is prepared to consider making an assembly kit, once it has been given the specific technical installation guide.

• Dal QR-Code è possibile approfondire i KIT di montaggio e installazione degli elettrodomestici in tabella (compresi nei prezzi degli elettrodomestici stessi o acquistabili separatamente). Fantin non si assume responsabilità per montaggio e installazione di altri elettrodomestici. In tal caso, si consiglia di consultare il documento - qui scaricabile - con un installatore qualificato. Frame Kitchen è compatibile con l'installazione di elettrodomestici Miele che hanno dimensioni adatte a quanto indicato nel documento scaricabile dal QR code. Per questi, Fantin si rende disponibile a valutare la produzione di un kit di montaggio, una volta ricevuta la specifica scheda tecnica di installazione.

• Über den QR-Code können Sie mehr über die Montage- und Bausätze (die im Lieferumfang der Geräte enthalten oder separat erhältlich sind) für die in der Tabelle aufgeführten Haushaltsgeräte erfahren. Fantin übernimmt keine Haftung für die Montage und Installation anderer Haushaltsgeräte. In diesem Fall empfehlen wir Ihnen, die Beschreibung, die hier heruntergeladen werden kann, mit einem qualifizierten Installateur zu konsultieren.

Frame Kitchen ist mit der Installation von Geräten der Marke Miele kompatibel, deren Abmessungen mit den Angaben der Beschreibung entsprechen, die über den QR-Code heruntergeladen werden kann. Für diese Geräte kann die Firma Fantin die Herstellung eines Montagesatzes in Erwägung ziehen, sobald sie das entsprechende Datenblatt erhalten hat.



**Bases / Basi / Basen**

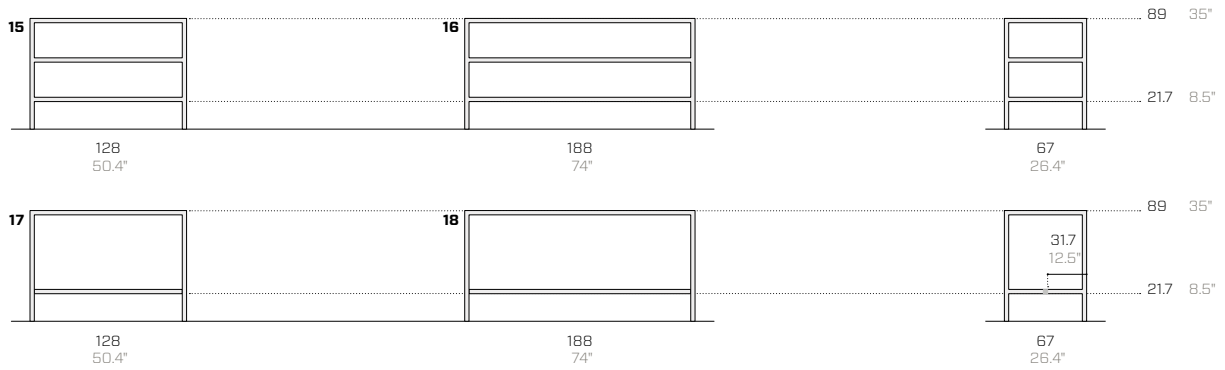

**Top / Top / Arbeitsplatten**



**Accessories and details / Accessori e dettagli / Zubehör und Details**

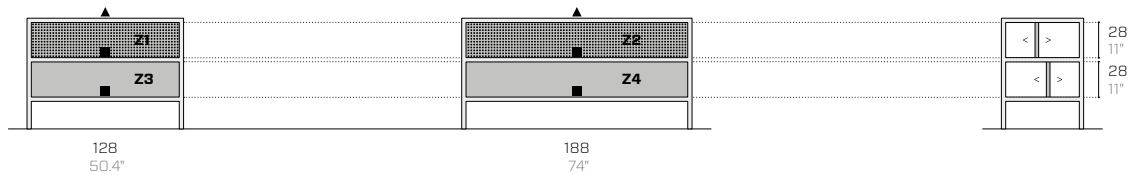

▲ Top (available in 4 versions)  
Top (disponibile in 4 versioni)  
Arbeitsplatte (in 4 Versionen erhältlich)

■ Lower shelves in metal (not replaceable)  
Ripiani inferiori in metallo (non sostituibili)  
Untere Regale aus Metall (nicht austauschbar)

Z. Full or perforated separator (freely positionable)  
Separatore pieno o forato (liberamente posizionabile)  
Voller oder perforierter Separator (frei positionierbar)





## Product / Prodotto / Produkt

## Packaging / Imballo / Verpackung

No.	Code	Dimensions (w-d-h)	Weight	Dimensions (w-d-h)	Weight	Vol pkg
N.	Codice	Dimensioni (l-p-h)	Peso	Dimensioni (l-p-h)	Peso	Vol. collo
Nr.	Code	Abmessungen (b-t-h)	Gewicht	Abmessungen (b-t-h)	Gewicht	Vol. Kollo
		cm	kg	cm	kg	mc

## Bases / Basi / Basen

<b>15</b>	FR88	128 67 89	60	150 80 107	103	1.30
<b>16</b>	FR81	188 67 89	75	200 80 107	118	1.80
<b>17</b>	FR95	128 67 89	32	150 80 107	75	1.30
<b>18</b>	FR96	188 67 89	38	200 80 107	81	1.80

## Metal top / Top in metallo / Arbeitsplatte aus Metall

<b>Y1</b>	FR88TOPS	128 67 0.3	16	132 71 10	20	0.10
<b>Y2</b>	FR81TOPS	188 67 0.3	23	192 71 10	28	0.20

Food-grade tops are found at the Finishes section / Top a uso alimentare indicati nella sezione Finiture / Die Lebensmittel-geeignete Arbeitsplatten sind im Abschnitt Finishes aufgeführt

## Glass top / Top in vetro / Mit Arbeitsplatte in Glas

<b>Y3</b>	FRV01A	128 67 0.6	13	143 82 12	20	0.20
<b>Y4</b>	FRV05A	188 67 0.6	19	203 82 12	29	0.20

## Satin finish stainless steel top (Barazza) / Top in acciaio Inox satinato (Barazza) / Arbeitsplatte aus Edelstahl mit Satin-Finish (Barazza)

<b>Y5</b>	FRX201S	128 67 0.4	28	137 80 21	50	0.30
<b>Y6</b>	FRX209S	188 67 0.4	40	197 80 21	50	0.40

## Vintage finish stainless steel top (Barazza) / Top in acciaio Inox Vintage (Barazza) / Arbeitsplatte aus Edelstahl mit Vintage-Finish (Barazza)

<b>Y7</b>	FRB41V	128 67 0.4	28	137 80 21	50	0.30
<b>Y8</b>	FRB71V	188 67 0.4	40	197 80 21	50	0.40

## Perforated separator / Separatore forato / Perforierter Separator

<b>Z1</b>	FRK05SF	128 28 4	4	132 32 5	9	0.10
<b>Z2</b>	FRK06SF	188 28 4	5	192 32 5	10	0.10

## Full separator / Separatore pieno / Voller Separator

<b>Z3</b>	FRK07SC	128 28 4	5	132 32 5	9	0.10
<b>Z4</b>	FRK08SC	188 28 4	6	192 32 5	10	0.10

## Wheel kit with colour-matching discs / Kit ruote con dischi in tinta / Radsatz mit farblich abgestimmten Scheiben

-	FRK31R8	8 3.5 10	2	20 10 10	3	0.10
-	FRK33R8	8 3.5 10	2	20 10 10	3	0.10

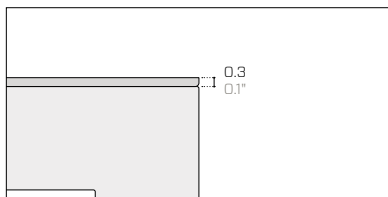

Metal top / Top in metallo / Arbeitsplatte aus Metall

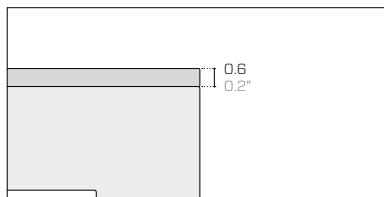

Glass top / Top in vetro / Arbeitsplatte aus Glas

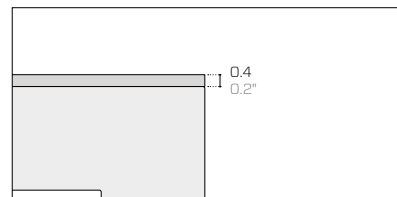

Stainless steel top / Top in inox / Arbeitsplatte aus Edelstahl

## Metal essentials

	<p><b>01.18</b>  <b>Black (RAL 9005)</b>            Nero / Schwarz            ---  <b>EM</b> ▲ ■</p>		<p><b>08.20</b>  <b>Rose quartz</b>            Rosa quarzo / Rosenquarz            ---  <b>EM</b> ▲</p>		<p><b>15.19</b>  <b>Forest green (RAL 6007)</b>            Verde bosco / Waldgrün            ---  <b>EM</b> ▲ ●</p>
	<p><b>02.18</b>  <b>Anthracite (RAL 7021)</b>            Antracite / Anthrazit            ---  <b>EM</b> ▲ ● ■</p>		<p><b>09.18</b>  <b>Ruby red (RAL 3003)</b>            Rosso rubino / Rubinrot            ---  <b>EM</b> ▲</p>		<p><b>16.19</b>  <b>Turquoise blue (RAL 5018)</b>            Blu turchese / Türkisblau            ---  <b>EM</b> ▲</p>
	<p><b>03.18</b>  <b>Fantin grey</b>            Grigio Fantin / Fantin-Grau            ---  <b>EM</b> ▲ ■</p>		<p><b>10.21</b>  <b>Flame red (RAL 3000)</b>            Rosso fuoco / Feuerrot            ---  <b>EM</b> ▲ ●</p>		<p><b>17.18</b>  <b>Pastel blue (RAL 5024)</b>            Blu pastello / Pastellblau            ---  <b>EM</b> ▲</p>
	<p><b>04.18</b>  <b>Light grey (RAL 7035)</b>            Grigio luce / Lichtgrau            ---  <b>EM</b> ▲ ■</p>		<p><b>11.21</b>  <b>Melon yellow (RAL 1028)</b>            Giallo melone / Melonengelb            ---  <b>EM</b> ▲ ●</p>		<p><b>18.21</b>  <b>Dusty blue (RAL 5014)</b>            Azzurro polvere / Staubiges blau            ---  <b>EM</b> ▲ ●</p>
	<p><b>05.19</b>  <b>Cloud grey</b>            Grigio nuvola / Wolkengrau            ---  <b>EM</b> ▲ ■</p>		<p><b>12.19</b>  <b>Zinc yellow (RAL 1018)</b>            Giallo zinco / Zinkgelb            ---  <b>EM</b> ▲</p>		<p><b>19.18</b>  <b>Gentian blue (RAL 5010)</b>            Blu genziana / Enzianblau            ---  <b>EM</b> ▲ ●</p>
	<p><b>06.18</b>  <b>White (RAL 9016)</b>            Bianco / Weiß            ---  <b>EM</b> ▲ ■</p>		<p><b>13.21</b>  <b>Pastel green (RAL 6019)</b>            Verde pastello / Weißgrün            ---  <b>EM</b> ▲ ●</p>		<p><b>20.19</b>  <b>Steel blue (RAL 5011)</b>            Blu acciaio / Stahlblau            ---  <b>EM</b> ▲</p>
	<p><b>07.21</b>  <b>Milk white (RAL 9001)</b>            Bianco latte / Milchweiß            ---  <b>EM</b> ▲ ● ■</p>		<p><b>14.18</b>  <b>Sage green (RAL 6021)</b>            Verde salvia / Salbeigrün            ---  <b>EM</b> ▲ ●</p>		<p><b>21.21</b>  <b>Coffee brown (RAL 8019)</b>            Marrone caffè / Kaffeebraun            ---  <b>EM</b> ▲</p>

Metal design

Metallic



**41.18  
Gold**  
Oro / Gold  
---  
EM ▲



**43.21  
Bronze**  
Bronzo / Bronze  
---  
EM ▲



**47.21  
Platinum**  
Platino / Platin  
---  
EM ▲



**46.21  
Titanium**  
Titanio / Titan  
---  
EM ▲



**45.21  
Silver**  
Argento / Silber  
---  
EM ▲



**44.18  
Iron**  
Ferro / Eisen  
---  
EM ▲



**42.19  
Rust**  
Ruggine / Rost  
---  
EM ▲●

Earth



**51.18  
Sand**  
Sabbia / Sand  
---  
EM ▲●

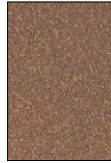

**57.21  
Clay**  
Creta / Lehm  
---  
EM ▲●



**52.18  
Moss**  
Muschio / Moos  
---  
EM ▲●



**53.18  
Basalt**  
Basalto / Basalt  
---  
EM ▲●



**54.18  
Stone**  
Pietra / Stein  
---  
EM ▲●



**55.18  
Amethyst**  
Ametista / Amethyst  
---  
EM ▲



**56.21  
Ocean**  
Oceano / Ozean  
---  
EM ▲

Surfaces / Superfici / Oberflächen

EM Embossed / Goffrato / Gaufriert

Use / Utilizzo / Verwenden

- ▲ Tops / Top / Arbeitsplatte
- Outdoor / Esterni / Außenbereich
- Food / Alimentare / Lebensmittel

## Glass essentials

**G01.23**  
**Black (RAL 9005)**

Nero / Schwarz

---

ET ▲●■

**G08.23**  
**Rose quartz**

Rosa quarzo / Rosenquarz

---

ET ▲●■

**G15.23**  
**Forest green (RAL 6007)**

Verde bosco / Waldgrün

---

ET ▲●■

**G02.23**  
**Anthracite (RAL 7021)**

Antracite / Anthrazit

---

ET ▲●■

**G09.23**  
**Ruby red (RAL 3003)**

Rosso rubino / Rubinrot

---

ET ▲●■

**G16.23**  
**Turquoise blue (RAL 5018)**

Blu turchese / Türkisblau

---

ET ▲●■

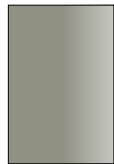
**G03.23**  
**Fantin grey**

Grigio Fantin / Fantin-Grau

---

ET ▲●■

**G10.23**  
**Flame red (RAL 3000)**

Rosso fuoco / Feuerrot

---

ET ▲●■

**G17.23**  
**Pastel blue (RAL 5024)**

Blu pastello / Pastellblau

---

ET ▲●■

**G04.23**  
**Light grey (RAL 7035)**

Grigio luce / Lichtgrau

---

ET ▲●■

**G11.23**  
**Melon yellow (RAL 1028)**

Giallo melone / Melonengelb

---

ET ▲●■

**G18.23**  
**Dusty blue (RAL 5014)**

Azzurro polvere / Staubiges blau

---

ET ▲●■

**G05.23**  
**Cloud grey**

Grigio nuvola / Walkengrau

---

ET ▲●■

**G12.23**  
**Zinc yellow (RAL 1018)**

Giallo zinco / Zinkgelb

---

ET ▲●■

**G19.23**  
**Gentian blue (RAL 5010)**

Blu genziana / Enzianblau

---

ET ▲●■

**G06.23**  
**White (RAL 9016)**

Bianco / Weiß

---

ET ▲●■

**G13.23**  
**Pastel green (RAL 6019)**

Verde pastello / Weißgrün

---

ET ▲●■

**G20.23**  
**Steel blue (RAL 5011)**

Blu acciaio / Stahlblau

---

ET ▲●■

**G07.23**  
**Milk white (RAL 9001)**

Bianco latte / Milchweiß

---

ET ▲●■

**G14.23**  
**Sage green (RAL 6021)**

Verde salvia / Salbeigrün

---

ET ▲●■

**G21.23**  
**Coffee brown (RAL 8019)**

Marrone caffè / Kaffeebraun

---

ET ▲●■

## Glass design

**G41.23****Gold**

Oro / Gold

---

ET ▲●■

**G51.23****Sand**

Sabbia / Sand

---

ET ▲●■

**G43.23****Bronze**

Bronzo / Bronze

---

ET ▲●■

**G57.23****Clay**

Creta / Lehm

---

ET ▲●■

**G47.23****Platinum**

Platino / Platin

---

ET ▲●■

**G52.23****Moss**

Muschio / Moos

---

ET ▲●■

**G46.23****Titanium**

Titanio / Titan

---

ET ▲●■

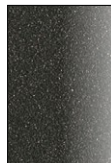
**G53.23****Basalt**

Basalto / Basalt

---

ET ▲●■

**G45.23****Silver**

Argento / Silber

---

ET ▲●■

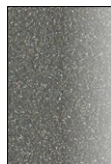
**G54.23****Stone**

Pietra / Stein

---

ET ▲●■

**44.18****Iron**

Ferro / Eisen

---

EM ▲●■

**G55.23****Amethyst**

Ametista / Amethyst

---

ET ▲●■

**42.19****Rust**

Ruggine / Rost

---

EM ▲●■

**G56.23****Ocean**

Oceano / Ozean

---

ET ▲●■

**Surfaces / Superfici / Oberflächen**

ET Etched / Acidato / Geätzt

**Use / Utilizzo / Verwenden**

- ▲ Tops / Top / Arbeitsplatte
- Outdoor / Esterni / Außenbereich
- Food / Alimentare / Lebensmittel

---

**Stainless steel**  
**Acciaio inox**  
**Edelstahl CNS**

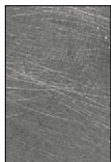

**K1.18**  
**Inox Vintage**

Inox Vintage / Inox Vintage

---

**HG ▲●■**



**K2.19**  
**Inox Satin**

Inox satinato / Inox satiniert

---

**HG ▲●■**

---

**Surfaces / Superfici / Oberflächen**

**HG** High Gloss / Lucido / Glänzend

---

**Use / Utilizzo / Verwenden**

- ▲ Tops / Top / Arbeitsplatte
- Outdoor / Esterni / Außenbereich
- Food / Alimentare / Lebensmittel

---

**Technical information**

**Metal** Non-toxic powder coating for interior use, with no heavy metals. Cured in an oven at 190 °C, following degreasing and phosphating. Guaranteed minimum thickness of 50 microns. Minimum resistance to salt spray of 200 hours (in accordance with the ASTM B117 standard). Some finishes are suitable for direct contact with food as required by Italian Law Decree D.M. 21/03/73 and subsequent updates. Requests for other RAL finishes can be considered.

**Glass** Extra-clear glass, with a thickness of 6 mm (0.24"), etched on the top, ground with a matt edge. Coated on the back with water-based paint in the 35 Fantin finishes.

**AISI 304 stainless steel** Kitchen top with a thickness of 4 mm (0.16") with Vintage (exclusive Barazza manual processing, making it quicker and easier to maintain) or satin finish.

---

**Informazioni tecniche**

**Metallo** Verniciatura per interni a polveri atossiche prive di metalli pesanti, con passaggio in forno a 190 °C, previo trattamento di sgrassaggio e fosfatazione. Spessore minimo garantito 50 micron, resistenza minima in nebbia salina pari a 200 ore (norma ASTM B117). Alcune finiture sono idonee al contatto diretto con alimenti come previsto dal decreto italiano D.M. 21/03/73 e successivi aggiornamenti. Altre finiture RAL valutabili su richiesta.

**Vetro** Vetro extra-chiaro di spessore 6 mm (0.24"), acidato superiormente, molato con bordo filo-opaco. Retroverniciato con verniciatura all'acqua nelle 35 finiture Fantin.

**Acciaio Inox AISI 304** Piano cucina spessore 4 mm (0.16") con finitura Vintage (lavorazione manuale esclusiva Barazza, la cui manutenzione è più semplice e agevole) o satinata.

---

**Technische Informationen**

**Metall** Die Pulverbeschichtung der gift- und schwermetallfreien Pulverlacke für Innenbereiche erfolgt im Lackierofen bei 190 °C nach vorheriger Entfettung und Phosphatierung. Die garantierte Mindeststärke der Lackschicht beträgt 50 Mikron bei einer Mindestprüfungsdauer von 200 Stunden im Salznebel (ASTM-Norm B117). Einige Oberflächen sind für den direkten Kontakt mit Lebensmitteln geeignet, wie in der Verordnung vorgesehen Italienisch D.M. 21/03/73 und folgende Aktualisierungen. Auf Anfrage können andere RAL-Finishes in Betracht gezogen werden.

**Glas** Extra klares Glas, Stärke 6 mm (0.24"), geätzte Oberseite, geschliffen mit bündiger, matter Kante. Rückseitig beschichtet mit Lack auf Wasserbasis in den 35 Farbtönen von Fantin.

**Edelstahl CNS AISI 304** Küchenarbeitsplatte Stärke 4 mm (0.16") mit Vintage-Finish (exklusive Handverarbeitung Barazza, die leicht und bequem zu pflegen ist) oder satiniert.

**Kitchens and workbenches from the Frame range, with a visible support structure and inset doors and drawers that are distinguishing visual features of the minimal design scheme.**

**Frame** made of 35 x 35 mm (1.38" x 1.38") square tubes. Concealed levelling feet, laterally adjustable.

**Top** made of extra-clear glass, with a thickness of 6 mm (0.24"), etched on the top, ground with a matt edge. Coated on the back with water-based paint in the 35 Fantin finishes.

**Top** (only for workbenches) made of metal with a thickness of 3 mm (0.12") and a bottom fibreboard filler panel.

**Doors** inset in the frame, made of a double layer of bent sheet metal. Door thickness: 20 mm (0.79"). Metal handles with a coating in a colour to match the doors. Soft-close dampening hinges. 95° door opening.

**Drawers** with fronts inset in the frame, made of a double layer of bent sheet metal. Drawer front thickness: 20 mm (0.79"). Metal handles with a coating in a colour to match the drawer fronts. Drawers with Hettich runners and built-in stabilization and soft-close systems. Capacity: 40 kg (88.18 lb).

**Sides and bases** inset in the frame, made of bent sheet metal; filled sides.

**Inside shelves** made of bent sheet metal.

**Optional backboards** inset in the frame, made of metal.

**Optional hobs** – electric induction and gas – from Barazza, Electrolux, Elica.

**Optional appliances** with custom installation kit, from AEG, Barazza, Electrolux, Falmecc.

**Optional accessories** – stainless steel sinks, roll-up draining mat, taps. Shelves, open compartments, panelling.

The kitchens are ready assembled (except for the tops).

**Cucine e banconi del programma Frame, caratterizzato dal telaio portante in vista ed ante e cassetti in luce, che diventano caratteristiche estetiche dal design minimale.**

**Telaio** in tubolare quadrato 35 x 35 mm (1.38" x 1.38"). Piedini livellatori nascosti, regolabili lateralmente.

**Top** in vetro extra-chiaro di spessore 6 mm (0.24"), acidato superiormente, molato con bordo filo-opaco. Retroverniciato con verniciatura all'acqua nelle 35 finiture Fantin.

**Top** in metallo (solo per banconi) di spessore 3 mm (0.12") con tamponamento inferiore in fibre di legno.

**Ante** in luce al telaio, in doppia lamiera piegata. Spessore delle ante 20 mm (0.79"). Maniglie in metallo verniciate in tinta con le ante. Cerniere ammortizzate. Apertura ante di 95°.

**Cassetti** con frontali in luce al telaio spessore 20 mm (0.79"), in doppia lamiera piegata. Maniglie in metallo verniciate in tinta con i frontali dei cassetti. Cassetti con guide Hettich, sistemi di stabilizzazione e soft-close integrati con portata 40 kg (88.18 lb).

**Fianchi e fondi** in luce al telaio, in lamiera piegata; fianchi tamponati.

**Ripiani** interni in lamiera piegata.

**Schiene opzionali** in metallo in luce al telaio.

**Piani cottura opzionali** – a induzione e a gas – Barazza, Electrolux, Elica.

**Elettrodomestici opzionali** – con kit di installazione personalizzato – AEG, Barazza, Electrolux, Falmecc.

**Accessori opzionali** – vasche in acciaio inox, griglia multiuso avvolgibile, rubinetti. Mensole, vani a giorno, boiserie.

Le cucine vengono fornite montate (top esclusi).

**Küchen und Werkbänke aus der Frame-Linie mit sichtbarem Tragegestell und bündigen Türen und Schubladen, die zu den ästhetischen Eigenschaften eines Minimaldesigns werden.**

**Gestell** aus Vierkantröhr 35 x 35 mm (1.38" x 1.38"). Unsichtbare, seitlich einstellbare Füße.

**Arbeitsplatte** aus extra klares Glas, Stärke 6 mm (0,24"), geätzte Oberseite, geschliffen mit bündiger, matter Kante. Rückseitig beschichtet mit Lack auf Wasserbasis in den 35 Farbtönen von Fantin.

**Arbeitsplatte** (nur für Werkbänke) aus 3 mm (0.12") starkem Metall mit unterer Holzfaserdämmung.

**Türen** aus Doppelfalz-Blech, bündig mit dem Gestell. Stärke der Türen 20 mm (0.79"). Pulverbeschichtete Metallgriffe gleichfarbig mit den Türen. Gedämpfte Scharniere. 95° Türöffnung.

**Schubladen** aus Doppelfalz-Blech, mit Fronten bündig mit dem Gestell. Schubladenfrontstärke: 20 mm (0.79"). Pulverbeschichtete Metallgriffe gleichfarbig mit den Schubladenfronten. Schubladen mit Führungsschienen Hettich mit Stabilisations- und Soft-Close-Systemen und mit einer Tragfähigkeit von 40 kg (88.18 lb).

**Seiten und Basen** aus Falzblech, bündig mit dem Gestell; bündig Seiten.

**Innere Einlegeböden** aus Falzblech.

**Optionale Rückwände** aus Metall, bündig mit dem Gestell.

**Optionale Kochfelder** – elektrische Induktion und Gas – von Barazza, Electrolux, Elica.

**Optionales Haushaltsgeräte** mit benutzerdefiniertes Bausatz, von AEG, Barazza, Electrolux, Falmecc.

**Optionales Zubehör** – Becken aus Edelstahl, aufrollbare Mehrzweckmatte, Wasserhähne. Regalbretter, offene Fächer, Wandverkleidung.

Die Küchen werden montiert geliefert (ohne Arbeitsplatten).



**Disclaimer / Esclusione di responsabilità / Haftungsausschluss**

Fantin Srl reserves the right to change the dimensions and features of the products contained in this technical data sheet at any time and without prior notice. The finishes illustrated are purely indicative as the accuracy tolerances of printing processes should be taken into account.

Fantin Srl si riserva la facoltà di modificare in qualsiasi momento e senza preavviso le dimensioni e l'esecuzione dei prodotti contenuti nella presente scheda tecnica. Le finiture riportate hanno valore indicativo in quanto soggette alle tolleranze dei processi di stampa.

Fantin Srl behält sich das Recht vor, die angegebenen Maße und Ausführungen der Produkte, welche dieses Produktblatt enthält, jederzeit ohne Vorankündigung zu ändern. Aufgrund drucktechnischer Abweichungen dienen die dargestellten Ausführungen nur der Illustration.

**Fantin Srl**

via San Vito, 43  
33080 - Bannia  
di Fiume Veneto (PN)  
Italia

t +39 0434 959 133  
f +39 0434 560 037  
fantin@fantin.com  
www.fantin.com



UNI EN ISO 9001