

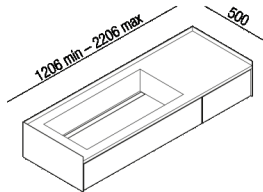





Washbasin/ countertop with fixed front  
 ADRP\_

Studio MK27, Mariana Ruzante, Marcio  
 Kogan, 2018

Self-bearing washbasin countertop made of  
 marble, framed on three sides by metal  
 plates. Available in different lengths.



**Materials**

-  Wood
-  Marble
-  Brass
-  Stainless steel
-  Leather

Countertop/washbasin made of white Carrara, grey Carnico, black Marquina, green Alpi or Emperador dark marble with outer structure in brushed burnished brass, natural polished or brushed\* brass or, on demand, satin-finish stainless steel.&#10;The washbasin, integrated into the top, has a fixed length of 80 cm and two depths; the shallower one allows the tap to be fitted directly on the countertop.&#10;The 20-cm high front panel under the washbasin is fixed, while the sides are drawers fitted with fully extendible slides with push-pull opening and soft-closing mechanism, (40 kg load capacity).&#10;The front panel finishes are available in white Carrara, grey Carnico or black Marquina marble, or in natural, brown, dark, ash grey oak, or in reconstituted wood with a teak finish, in raw, green or black leather or &#10;in burnished brushed brass, natural polished or brushed\* brass or, on demand, in satin stainless steel.&#10;The casing and inside of the drawers are in the same finish as the front panels when they are made of wood. One of the wood finishes must be chosen if the front panels are in marble, leather or metal.&#10;All the front panels are supported by an MDF panel lacquered in dark grey.&#10; \* Customised finishes starting from a base of natural brass are available on request.

Height:	25 cm	9" 27/32 inches
Depth:	50 cm	19" 3/4 inches

Note: DR is available in lengths ranging from 120 to 220 cm. NB: front panels cannot be produced in Verde Alpi and Emperador dark marble.



Main dimensions: for mounterd tap

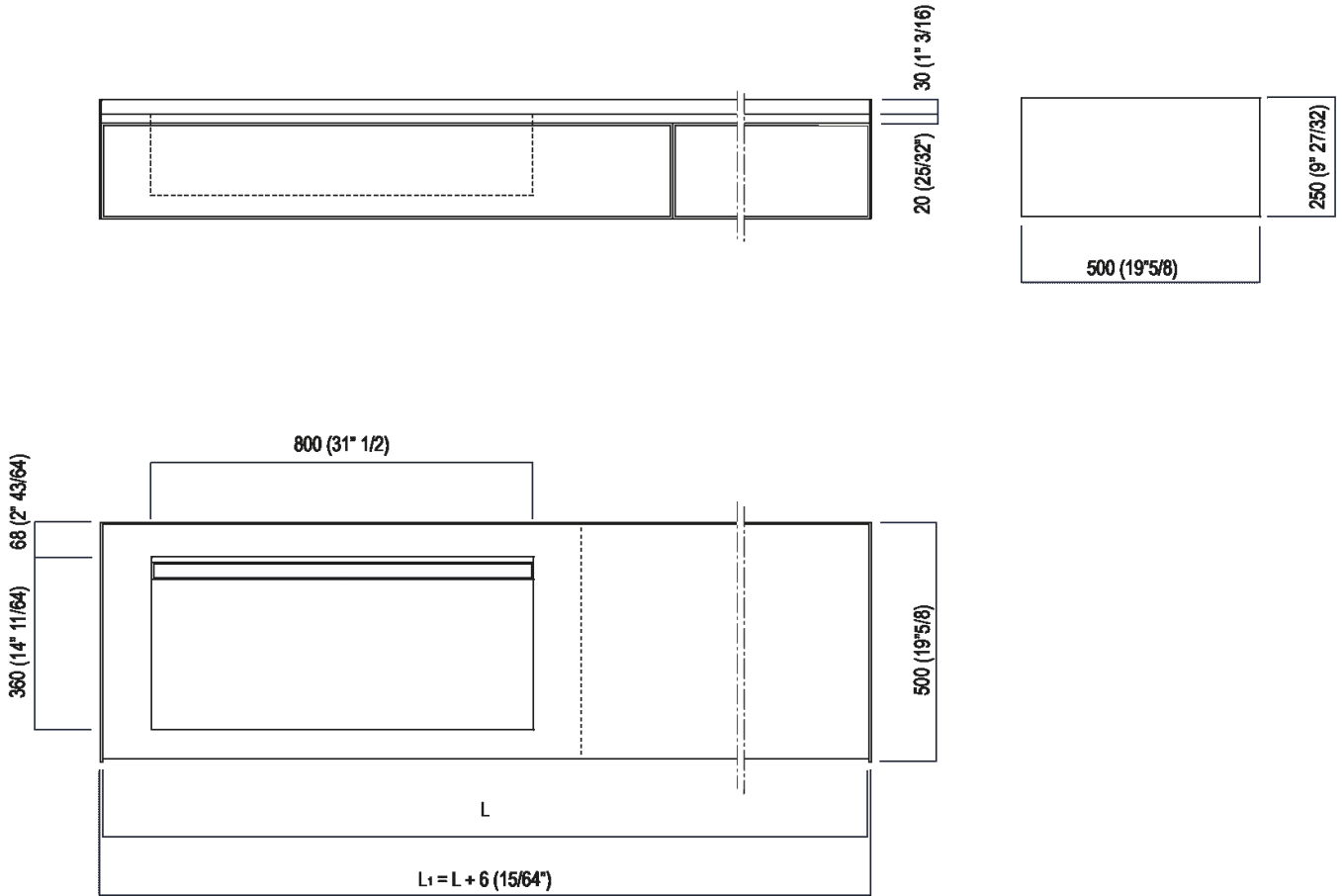



Main dimensions: for countertop tap

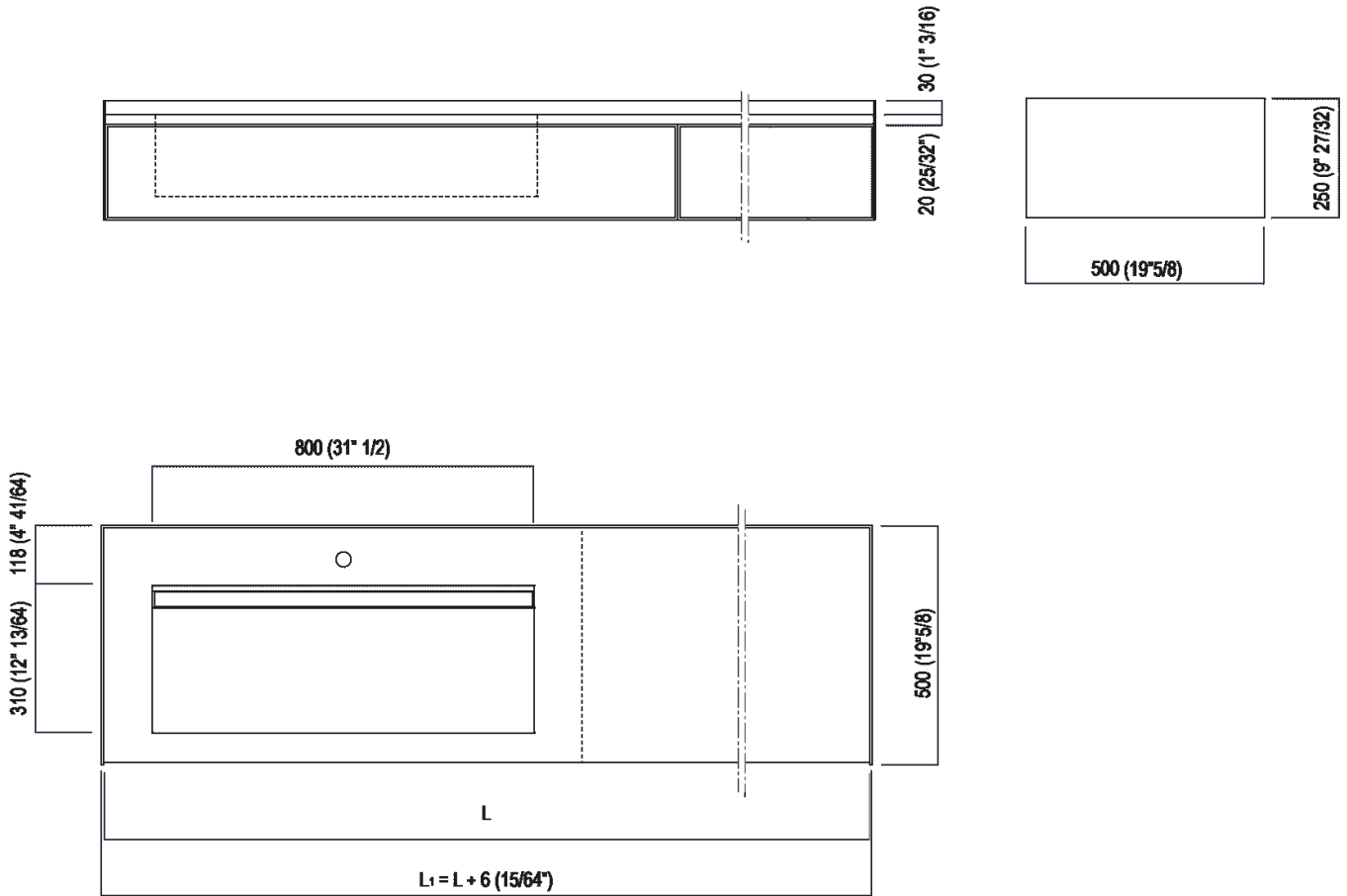



**Installation notes**

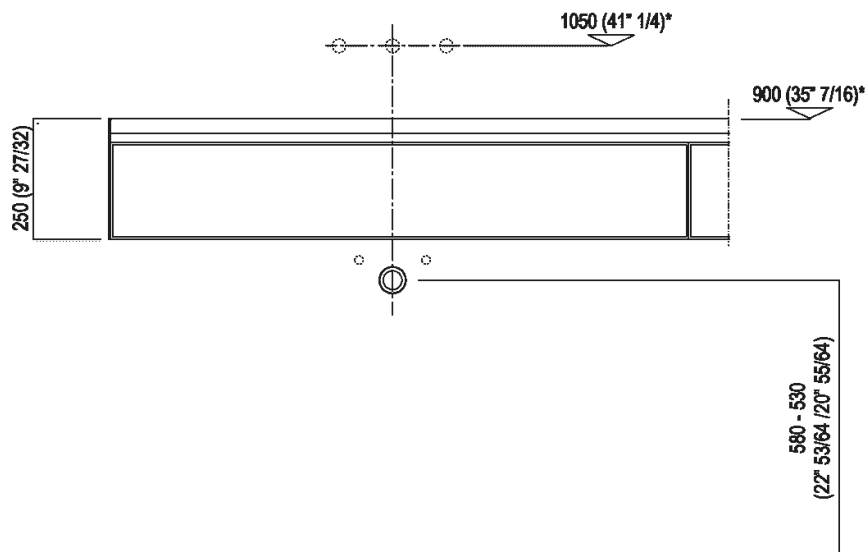

Scarico per sifone a bottiglia  
 Drain for bottle trap

\*h.consigliata / advised h.



Installation notes

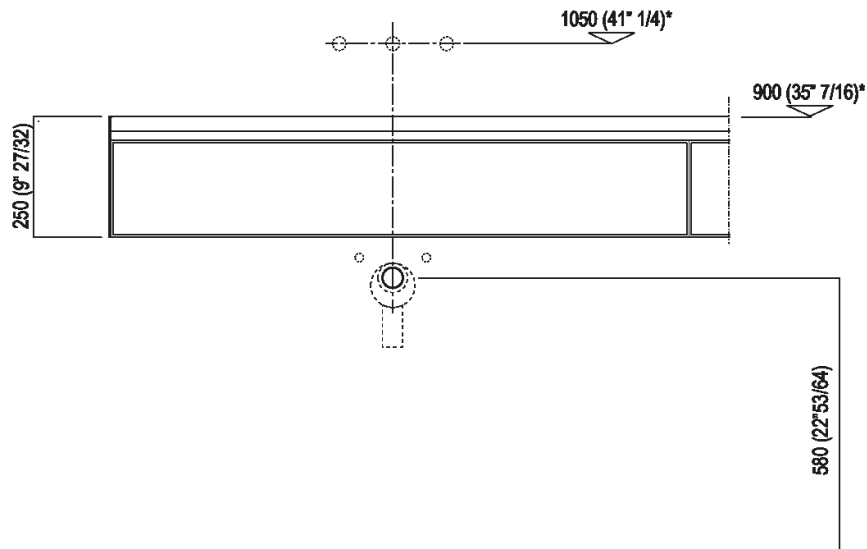

Scarico per sifone ad incasso  
Drain for concealed waste trap  
(.PLA456 + AKIT0731)









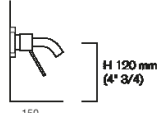
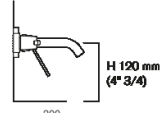

\*h.consigliata / advised h.

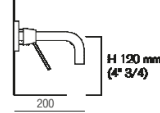
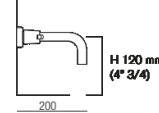

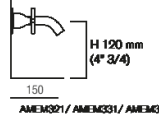
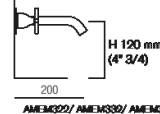
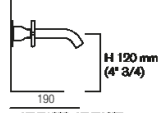
Positioning taps

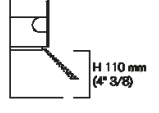
POSIZIONE RUBINETTERIA / TAP POSITION

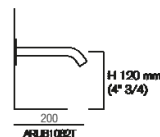
Altezza consigliata / Recommended height

<b>FEZ2</b>	 115 AFEZ001	 150 AFEZ011	 200 AFEZ002/ AFEZ012	
<b>FEZ</b>	 115 ARUE10012S - ARUE10012D	 200 ARUE020	 200 ARUE13020	 200 ARUE12020
<b>MEMORY</b>	 116 AMEM031	 150 AMEM021/ AMEM031/ AMEM033	 200 AMEM022/ AMEM032/ AMEM034	
		 190 ARUE1036, ARUE1037		
<b>SEN</b>	 150 ASEM010	 110 ASEM012RS		
<b>SQUARE</b>	 125 ARUE1023	 110 ARUE020	 200 ARUE1021	 165 ARUE020, ARUE021, ARUE1023, ARUE1023 (C)
			 165 H 180 mm (7" 3/32)	



Abacus compositions The front panel in line with the washbasin is fixed, the sides are drawers.

